



# ALONDRA

BABY FURNITURE & DECOR



CATALOGUE



## CO-SLEEPERS



### Page 3

**Co-sleepers** | Colecho  
Cododo | *Beistellbetten*  
Fianco letto

## MONTESSORI



### Page 23

**Montessori beds** | Camas Montessori  
Lits Montessori | *Montessori-Betten*  
Lettini Montessori

## KONVERS

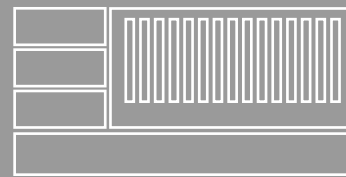

### Page 31

**Convertible cribs** | Cunas convertibles  
Lits bébé évolutifs | *Verwandelbare Babybetten*  
Lettini trasformabili

## BABY FURNITURE

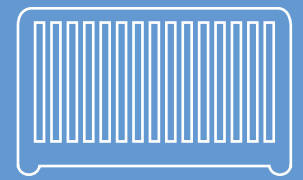

### Page 57

**Baby rooms** | Habitaciones infantiles  
Chambres de bébé | *Babyzimmer*  
Camerette per bambini

## COTS & BATH CHANGERS



### Page 81

**Cots and bath changers** | Cunas y bañeras  
Lits bébé et baignoires | *Babybetten + Waschtische*  
Lettini e bagnetti

## JUNIOR FURNITURE



### Page 87

**Junior furniture** | Mobiliario juvenil  
Mobilier junior | *Jugendmöbel*  
Mobili junior

## URBAN BAGS



### Page 91

**Nursing bags** | Bolsos de maternidad  
Sacs à langer | *Wickeltaschen*  
Borse mamma

## TOYS



### Page 99

**Toys** | Juguetes  
Jouets | *Spielzeuge*  
Giocattoli

## NURSERY LIGHTING



### Page 105

**Lamps & deco** | Lámparas y decoración  
Lampes et décoration | *Lampen und Dekoration*  
Lampade e decorazione

## NURSING CHAIRS



### Page 113

**Nursing chairs** | Sillones de lactancia  
Fauteuils d'allaitement | *Stillsessel*  
Poltrone allattamento

## TEXTILES



### Page 121

**Textiles** | Textiles  
Layette | *Textilien*  
Tessile

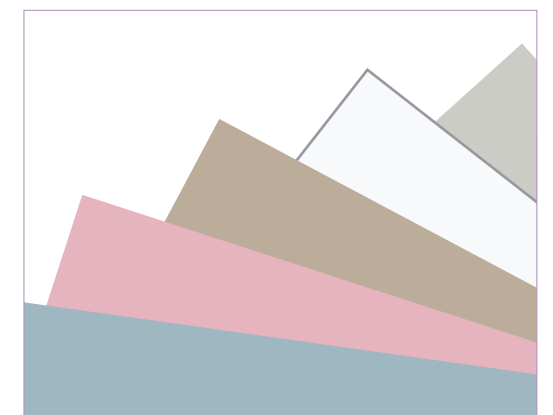

### Page 144

**Colours** | Colores  
Couleurs | *Farben*  
Colori







CO-SLEEPING CRIB | MINICUNA DE COLECHO  
BERCEAU CODODO | BEISTELLBETT | CULLA FIANCO LETTO



50x80



**7 heights / alturas**

(Mattress included)

- 54,3 cm
- 51,1 cm
- 47,9 cm
- 44,7 cm
- 41,5 cm
- 38,3 cm
- 35,1 cm

① Min. 65,1 cm / Max. 84,3 cm

② 89,2 cm

③ 63 cm

ONQUE



INCLUDES | INCLUYE | INCLUT | BEINHALTET | COMPRENDE

SIZES | MEDIDAS  
MESURES | MAßE | MISURE

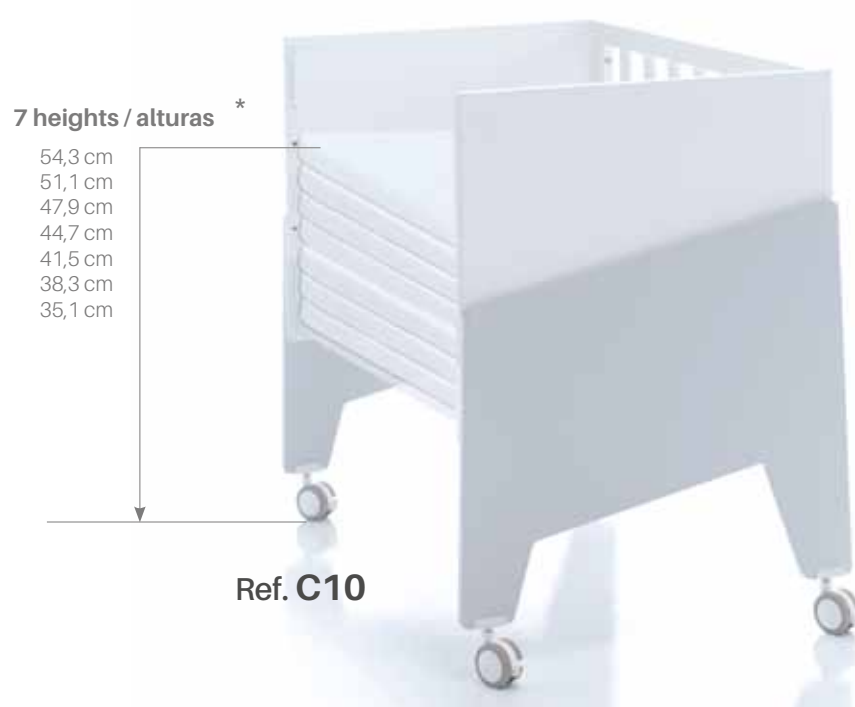

**Co-sleeping crib**  
 Minicuna de colecho  
 Berceau cododo  
 Beistellbett  
 Culla fianco letto



**4 wheels with brake**  
 4 ruedas con freno  
 4 roues avec frein  
 4 Räder mit Bremse  
 4 ruote con freno

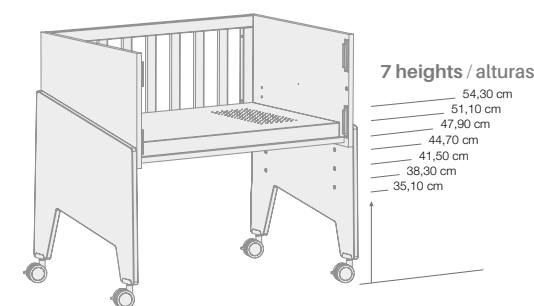

\* Height with mattress (5cm) included  
 Altura con colchón de 5cm incluido



**Attachment straps**  
 Sistema de sujeción a la cama incluido  
 Système de fixation au lit  
 Befestigungssystem am Bett  
 Sistema di ancoraggio al letto

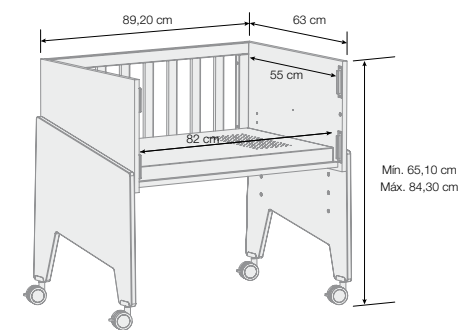

Textiles 50x80 cm

\* Height with mattress included | Altura con colchón incluido  
 Hauteur du couchage, matelas compris | Höhenverstellung mit Matratze | Altezza con materassino incluso

DETALLES | DETAILS | DÉTAILS | DETAILS | DETTAGLI



**Straps with velcro**  
 Cintas con velcro  
 Sangles à scratch  
 Klett-Gurten  
 Dettaglio cinghie con velcro



**Co-sleeping stage**  
 Etapa colecho  
 Étape cododo  
 Beistellbett Etappe  
 Fase fianco letto



**Fastening straps attached to the bed**  
 Detalle sistema sujeción unido a la cama  
 Système de fixation au lit  
 Befestigungssystem am Bett  
 Dettaglio sistema ancoraggio letto



**Inside dimensions**  
 Medidas interiores minicuna  
 Mesures intérieures  
 Innenmaße  
 Misure interne

SIZE  
50x80  
cm





**REF. 650**

4 PIECES  
 Quilt with padding included  
 Bumper 3 sides  
 Bumper 1 side  
 Breathable mattress

4 PIEZAS  
 Colcha con relleno  
 Protector 3 lados  
 Protector 1 lado  
 Colchón antiahogó plástico

4 PIÈCES  
 Couvre-lit avec rembourrage  
 Tour de lit 3 côtés  
 Tour de lit 1 côté  
 Matelas anti-étouffement

4 STÜCKE  
 Bettdecke mit Füllung  
 3-seitiges Nestchen  
 1-seitiges Nestchen  
 Matratze Antierstickungsgefahr

4 PEZZI  
 Plumoncino con imbottitura  
 Paracolpi 3 lati  
 Paracolpi 1 lato  
 Materassino antisoffoco plastificato



**REF. 650S**

3 PIECES  
 Quilt with padding included  
 Bumper 3 sides  
 Bumper 1 side

3 PIEZAS  
 Colcha con relleno  
 Protector 3 lados  
 Protector 1 lado

3 PIÈCES  
 Couvre-lit avec rembourrage  
 Tour de lit 3 côtés  
 Tour de lit 1 côté

3 STÜCKE  
 Bettdecke mit Füllung  
 3-seitiges Nestchen  
 1-seitiges Nestchen

3 PEZZI  
 Plumoncino con imbottitura  
 Paracolpi 3 lati  
 Paracolpi 1 lato

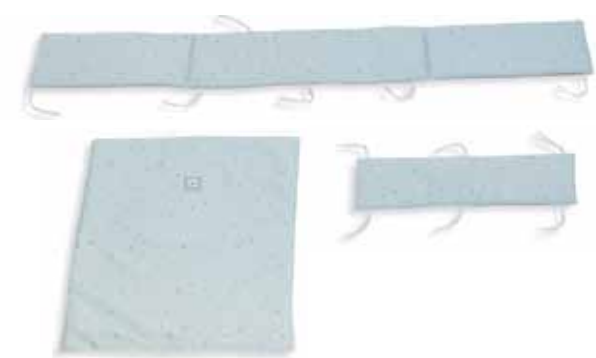

**MEASURES | MEDIDAS**  
 MESURES | *MAßE* | MISURE

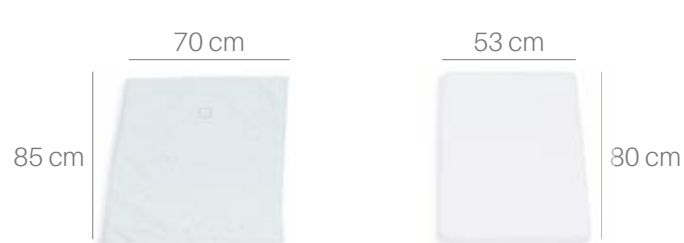

**DETAILS | DETALLES | DÉTAILS | *DETAILS* | DETTAGLI**



2 bumper velcro fastenings included  
 2 sujeciones protector incluidas  
 2 fixations de scratch incluses  
 2 Klett-Befestigungen inklusive  
 2 ancoraggi velcro paracolpi inclusi



Reversible bumper  
 Protector reversible / 2 caras  
 Tour de lit réversible  
 Doppelseitiges Nestchen  
 Paracolpi reversibile 2 lati

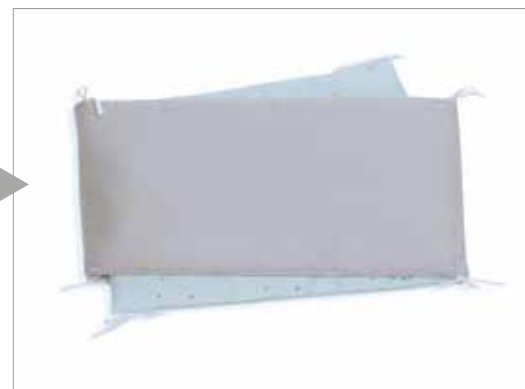

**OPTION | OPCIÓN**  
 OPTION | *OPTION* | OPZIONE



Memory foam mattress  
 Colchón viscoelástica opcional  
 Matelas à mémoire de forme  
 Matratze aus Viscoschaum  
 Materassino memory foam opzionale

Ref. ZY50-80  
 5 cm  
 80 cm  
 50 cm

SIZE  
50x80  
cm

 Crib without textile & mattress Minicuna sin textil y sin colchón Berceau sans textile et matelas Stubenwagen ohne Textil und Matratze Culla senza tessile e materassino	 Textile & mattress (without crib) Textil+colchón (sin minicuna) Textile et matelas (sans berceau) Textil und Matratze (ohne Wiege) Tessile+materassino (senza culla)	 Textile (without crib) Textil (sin minicuna) Textile (sans berceau) Textil (ohne Wiege) Tessile (senza culla)						
	650-055	650S-055	---	---	---	<b>C1055-TX055</b>	<b>C1077-TX055</b>	<b>C1078-TX055</b>
	650-111	650S-111	<b>C1051-TX111</b>	---	---	---	<b>C1077-TX111</b>	<b>C1078-TX111</b>
	650-112	650S-112	---	<b>C1052-TX112</b>	---	---	<b>C1077-TX112</b>	<b>C1078-TX112</b>
	650-153	650S-153	---	---	<b>C1053-TX153</b>	---	<b>C1077-TX153</b>	<b>C1078-TX153</b>
	650-178	650S-178	<b>C1051-TX178</b>	<b>C1052-TX178</b>	<b>C1053-TX178</b>	<b>C1055-TX178</b>	<b>C1077-TX178</b>	<b>C1078-TX178</b>
	650-179	650S-179	---	---	---	---	<b>C1077-TX179</b>	<b>C1078-TX179</b>
	650-181	650S-181	---	---	---	<b>C1055-TX181</b>	<b>C1077-TX181</b>	<b>C1078-TX181</b>
	650-182	650S-182	---	<b>C1052-TX182</b>	---	---	<b>C1077-TX182</b>	<b>C1078-TX182</b>

**Cot | Cuna**  
Lit bébé | *Babybett* | Lettino

STAGE  
**2**  
1-2 years



**Toddler bed | Camita infantil**  
Lit cadet | *Juniorbett* | Lettino sponda junior

STAGE  
**3**  
2-5 years



\* Additional kit ref. WJB180-M77 (page 21)

**Couch | Sofá infantil**  
Canapé | *Sofa* | Divanetto

STAGE  
**4**  
5-7 years



\* Additional kit ref. WJB180-M77 (page 21)

**Desk | Escritorio infantil**  
Bureau | *Schreibtisch* | Scrivania

STAGE  
**5**  
5-14 years



\* 5 stages with additional kits or accessories | 5 etapas con packs o accesorios adicionales  
\* 5 étapes avec des kits ou accessoires supplémentaires | 5 Etappen mit zusätzlichen Kits oder Zubehör | 5 fasi con packs o accessori opzionali

CO-SLEEPING COT | CUNA DE COLECHO  
LIT BÉBÉ CODODO | BEISTELLBETT | LETTINO FIANCO LETTO



60x120

Co-sleeping cot | Cuna de colecho  
Lit bébé cododo | Beistellbett | Lettino fianco letto

STAGE  
**1**  
0-1 years



91 x 126,1 x 72,9 cm



\* Additional kit ref. WCO180-M70 (page 21)

OMNI



C181-M7751 + WJB180-M77  
(pages 18-19)



633-111

B754-M7751



OMNI CIELO



Co-sleeping cot | Cuna de colecho  
Lit bébé cododo | Beistellbett  
Lettino fianco letto  
\*Additional kit WCO180-70 (p. 21)



Cot 60x120 | Cuna 60x120  
Lit bébé 60x120 | Babybett 60x120  
Lettino 60x120



Toddler bed | Camita infantil  
Lit cadet | Juniorbett  
Lettino sponda junior  
\*Additional kit WJB180-M77 (p. 21)



Couch | Sofá infantil  
Canapé | Sofa  
Divanetto  
\*Additional kit WJB180-M77 (p. 21)



Desk | Escritorio infantil  
Bureau | Schreibtisch  
Scrivanía



60x120

633-112

C181-M7752 + WJB180-M77  
(pages 18-19)

B754-M7752



Co-sleeping cot | Cuna de colecho  
Lit bébé cododo | Beistellbett  
Lettno fianco letto  
\*Additional kit WCO180-70 (p. 21)



Cot 60x120 | Cuna 60x120  
Lit bébé 60x120 | Babybett 60x120  
Lettno 60x120



Toddler bed | Camita infantil  
Lit cadet | Juniorbett  
Lettno sponda junior  
\*Additional kit WJB180-M77 (p. 21)



Couch | Sofá infantil  
Canapé | Sofa  
Divanetto  
\*Additional kit WJB180-M77 (p. 21)



Desk | Escritorio infantil  
Bureau | Schreibtisch  
Scrivanía



## OMNI ARENA



**Co-sleeping cot** | Cuna de colecho  
Lit bébé cododo | Beistellbett  
Lettino fianco letto  
\*Additional kit WCO180-70 (p. 21)



**Cot 60x120** | Cuna 60x120  
Lit bébé 60x120 | Babybett 60x120  
Lettino 60x120



**Toddler bed** | Camita infantil  
Lit cadet | Juniorbett  
Lettino sponda junior  
\*Additional kit WJB180-M77 (p. 21)



**Couch** | Sofá infantil  
Canapé | Sofa  
Divanetto  
\*Additional kit WJB180-M77 (p. 21)



**Desk** | Escritorio infantil  
Bureau | Schreibtisch  
Scrivanía





B754-M7700

C181-M7700 + WCO180-70  
(pages 18-19)



Co-sleeping cot | Cuna de colecho  
Lit bébé cododo | Beistellbett  
Lettno fianco letto  
\*Additional kit WCO180-70 (p. 21)



Cot 60x120 | Cuna 60x120  
Lit bébé 60x120 | Babybett 60x120  
Lettno 60x120



Toddler bed | Camita infantil  
Lit cadet | Juniorbett  
Lettno sponda junior  
\*Additional kit WJB180-M77 (p. 21)



Couch | Sofá infantil  
Canapé | Sofa  
Divanetto  
\*Additional kit WJB180-M77 (p. 21)



Desk | Escritorio infantil  
Bureau | Schreibtisch  
Scrivanía

\* 5 stages with additional kits or accessories (+info pages 18-19) | 5 etapas con packs o accesorios adicionales (+info págs. 18-19)  
5 étapes avec des kits ou accessoires supplémentaires (+info pages 18-19) | 5 Etappen mit zusätzlichen Kits oder Zubehör (+info Seiten 18-19)  
5 fasi con packs o accessori opzionali (+info pagine 18-19)



633-055

B754-M7755

C181-M7755 + WCO180-70  
(pages 18-19)



OMNI MINT



**Co-sleeping cot** | Cuna de colecho  
Lit bébé cododo | Beistellbett  
Lettino fianco letto  
\*Additional kit WCO180-70 (p. 21)



**Cot 60x120** | Cuna 60x120  
Lit bébé 60x120 | Babybett 60x120  
Lettino 60x120



**Toddler bed** | Camita infantil  
Lit cadet | Juniorbett  
Lettino sponda junior  
\*Additional kit WJB180-M77 (p. 21)



**Couch** | Sofá infantil  
Canapé | Sofa  
Divanetto  
\*Additional kit WJB180-M77 (p. 21)



**Desk** | Escritorio infantil  
Bureau | Schreibtisch  
Scrivania



Co-sleeping cot | Cuna de colecho  
Lit bébé cododo | Beistellbett  
Lettino fianco letto  
\*Additional kit WCO180-70 (p. 21)



Cot 60x120 | Cuna 60x120  
Lit bébé 60x120 | Babybett 60x120  
Lettino 60x120



Toddler bed | Camita infantil  
Lit cadet | Juniorbett  
Lettino sponda junior  
\*Additional kit WJB180-M77 (p. 21)



Couch | Sofá infantil  
Canapé | Sofa  
Divanetto  
\*Additional kit WJB180-M77 (p. 21)



Desk | Escritorio infantil  
Bureau | Schreibtisch  
Scrivanía

## OMNI PACKS

**C181**

2in1



C181

**PACK K10**

3in1



C181

+



WCO180-70

**PACK K11**

2in1



C181

+



606



607

**PACK K12**

3in1



C181

+



WCO180-70



606

+



607

## OMNI STAGES

2in1

2 STAGES



+



**Cot**  
Cuna  
Lit bébé  
Babybett  
Letтино

**Desk**  
Escritorio  
Bureau  
Schreibtisch  
Scrivania

3in1

3 STAGES



+



+



**Co-sleeping cot**  
Cuna de colecho  
Lit cododo  
Beistellbett  
Letтино fianco letto

**Cot**  
Cuna  
Lit bébé  
Babybett  
Letтино

**Desk**  
Escritorio  
Bureau  
Schreibtisch  
Scrivania

PACK K13

4in1



C181



WJB180-M77



606



607

PACK K14

5in1



C181



WCO180-70



606



607



WJB180-M77

PACK K15

4in1



C181



ZV60-120



606



607



WJB180-M77

PACK K16

5in1



C181



WCO180-70



ZV60-120



606



607



WJB180-M77

OMNI STAGES

4in1

4 STAGES



**Cot**  
Cuna  
Lit bébé  
Babybett  
Lettino



**Toddler bed**  
Camita  
Lit cadet  
Juniorbett  
Lettino sponda junior



**Couch**  
Sofá infantil  
Canapé  
Sofa  
Divanetto



**Desk**  
Escritorio  
Bureau  
Schreibtisch  
Scrivania

5in1

5 STAGES



**Co-sleeping cot**  
Cuna de colecho  
Lit cododo  
Beistellbett  
Lettino fianco letto



**Cot**  
Cuna  
Lit bébé  
Babybett  
Lettino



**Toddler bed**  
Camita  
Lit cadet  
Juniorbett  
Lettino sponda junior



**Couch**  
Sofá infantil  
Canapé  
Sofa  
Divanetto



**Desk**  
Escritorio  
Bureau  
Schreibtisch  
Scrivania

**5 STAGES | 5 ETAPAS** \*  
 5 ÉTAPES | 5 ETAPPEN | 5 FASI



**Co-sleeping cot**  
 Cuna de colecho  
 Lit bébé cododo  
*Beistellbett*  
 Lettino fianco letto



**Cot**  
 Cuna  
 Lit bébé  
*Babybett*  
 Lettino



**Toddler bed**  
 Camita junior  
 Lit cadet  
*Juniorbett*  
 Lettino sponda junior



**Couch**  
 Sofá infantil  
 Canapé  
 Sofa  
 Divanetto



**Desk**  
 Escritorio infantil  
 Bureau  
*Schreibtisch*  
 Scrivania

\* **5 stages with additional kits or accessories**  
 5 etapas con packs o accesorios adicionales  
 5 étapes avec des kits ou accessoires supplémentaires  
 5 Etappen mit zusätzlichen Kits oder Zubehör  
 5 fasi con packs o accessori opzionali

**CO-SLEEPER STAGE DETAILS | DETALLES ETAPA DE COLECHO**  
 DÉTAILS ÉTAPE CODODO | *DETAILS BEISTELLBETT ETAPE* | DETTAGLI FASE FIANCO LETTO

**5 heights / alturas** \*\*

- 62,7 cm
- 56,3 cm
- 49,9 cm
- 43,5 cm
- 40,3 cm

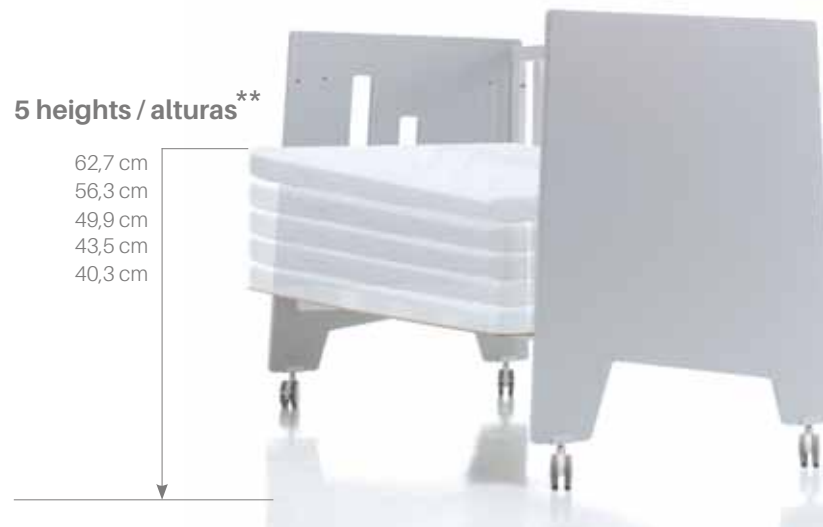

\*\* **Height with mattress included** | *Altura con colchón incluido*  
 Hauteur du couchage, matelas compris | *Höhenverstellung mit Matratze* | Altezza con materassino incluso



Ref. WCO180-70

**Co-sleeping pack** | *Kit colecho*  
 Pack cododo | *Baistellbett-Set* | Set fianco letto



**Mattress extension outside**  
 Suplemento colchón en posición exterior  
 Rallonge de matelas à l'extérieur  
*Matratzenverbreiterung außen*  
 Materassino supplementare montato esternamente



**2 positions for the mattress and mattress extension**  
 2 posiciones de colchón y suplemento de colchón  
 2 positions du matelas et du rallonge de matelas  
 2 Positionen der Matratze und Matratzenverbreiterung  
 2 posizioni materasso e materassino supplementare



**Mattress extension inside**  
 Suplemento colchón en posición interior  
 Rallonge de matelas à l'intérieur  
*Matratzenverbreiterung innen*  
 Materassino supplementare montato internamente



Ref. WCO180-70

**Fastening straps included in the co-sleeping kit**  
 Cintas anclaje incluidas en kit colecho  
 Sangles de fixation incluses dans le kit  
*Befestigungsgurten im Beistellbett-Kit inbegriffen*  
 Cinghie ancoraggio incluse nel kit



**Fastening straps attached to the bed**  
 Detalle sistema sujeción unido a la cama  
 Systeme de fixation au lit  
*Befestigungssystem am Bett*  
 Dettaglio sistema ancoraggio letto



**Straps with velcro**  
 Detalle de cintas con velcro  
 Sangles à scratch  
*Klett-Gurten*  
 Dittaglio cinghie con velcro

1

Co-sleeping pack | Kit colecho | Pack cododo | Beistellbett-Set | Set fianco letto

Ref. WCO180-70

**Includes:**  
Co-sleeping extension board  
Fastening straps  
Foam mattress extension  
Hardware

*Beinhaltet:*  
Verlängerungsseite für Beistellbett  
Befestigungsgurten  
Matratzenverbreiterung  
Schraubensatz

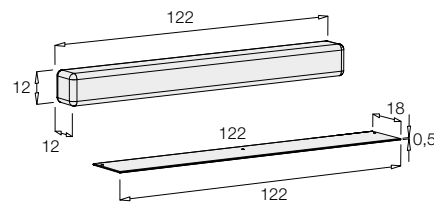

**Incluye:**  
Tablero extensión colecho  
Set de cintas de sujeción  
Suplemento colchón espuma  
Herrajes

*Include:*  
Tavoletta estensione base lettino  
Set cinghie ancoraggio  
Materassino supplementare gomma piuma  
Ferramenta

**Inclut:**  
Planche pour extension cododo  
Sangles de fixation  
Rallonge de matelas  
Visserie



2

Safety guard | Barrera cuna 2 posiciones | Barrière junior | Absturzsicherung | Sponda junior

Ref. WJB180-M77

**Includes:**  
Safety guard / Base for couch  
Hardware  
It can be used for 2 stages: firstly, to transform the cot into a toddler bed and, subsequently, by turning it around, into a couch.

*Beinhaltet:*  
Absturzsicherung / Boden für Sofa  
Schraubensatz  
Es ermöglicht, das Babybett zu einem Juniorbett und später zu einem sofa umzubauen.

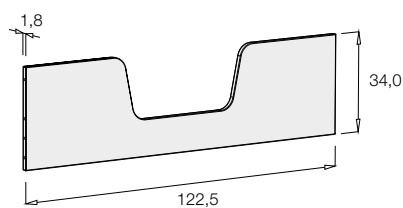

**Incluye:**  
Barrera junior / base sofá  
Herrajes  
Sirve para transformar la cuna en 2 etapas, primero como camita junior y después, dándole la vuelta, como sofá infantil.

*Include:*  
Sponda junior / base divanetto  
Ferramenta  
Serve per trasformare il lettino in 2 fasi: prima in lettino aperto, poi in divanetto.

**Inclut:**  
Barrière junior / base canapé  
Visserie  
Le pack permet de transformer le lit en 2 étapes: d'abord en tant que lit cadet et, ensuite, en canapé.

2 POSITIONS | 2 POSICIONES  
2 POSITIONS | 2 POSITIONEN | 2 POSIZIONI

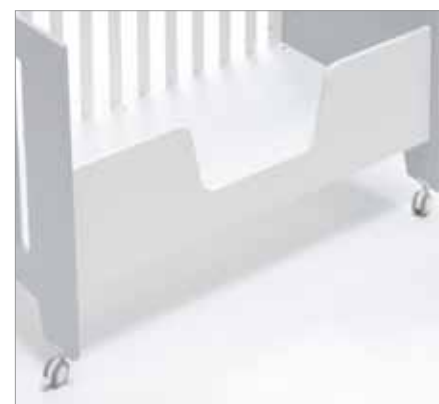





# MONTESORI



**MONTESORI BEDS | CAMAS MONTESORI**  
LITS MONTESORI | *MONTESORI-BETTEN* | LETTI MONTESORI



HOMY **ARROW**



HOMY **INDIANA ROSA**



HOMY **MARE**



HOMY **MINT**



HOMY **INDIANA BLU**

**2 SIZES | 2 MEDIDAS**  
2 MESURES | 2 MÄßE | 2 MISURE



BABY  
70x140

**HOMY** Ref. NA140-M70

↑ 140 cm → 152 cm ↻ 82 cm



HOMY **CAREZZA**



HOMY **ARENA**



JUNIOR  
90x200

**HOMY XL** Ref. NA200-M70

↑ 137 cm → 212 cm ↻ 102,5 cm

# MONTESSORI HOMY

2 SIZES: 70x140 / 90x200 cm

MATTE  
FINISH



HOMY (70 x 140)  
140 x 152 x 82 cm  
↑ → ↻

HOMY XL (90 x 200)  
137 x 212 x 102,5 cm  
↑ → ↻



INDY **ARROW**



INDY **INDIANA ROSA**



INDY **MARE**



INDY **MINT**



INDY **INDIANA BLU**



INDY **CAREZZA**



INDY **ARENA**

**SIZES | MEDIDAS**  
MESURES | *MAßE* | MISURE



BABY  
70x140

**INDY** Ref. NC141-M70  
↑ 144 cm → 147,7 cm ↻ 74,7 cm

# MONTESSORI **INDY**

70x140 cm





**MATTE**  
FINISH

















INDY (70 x 140)  
144 x 147,7 x 74,7 cm  
↑ → ↻

BABY  
70x140

JUNIOR  
90x200

	<p><b>HOMY frame</b> Estructura HOMY Structure HOMY HOMY Bettgestell Struttura HOMY</p>	<p><b>HOMY</b> NA140-M70</p> <p>↑ 140 cm → 152 cm ↗ 82 cm</p>	<p><b>HOMY XL</b> NA200-M70</p> <p>↑ 137 cm → 212 cm ↗ 102,5 cm</p>
	<p><b>INDY frame</b> Estructura INDY Structure INDY INDY Bettgestell Struttura INDY</p>	<p><b>INDY</b> NC141-M70</p> <p>↑ 144 cm → 147,7 cm ↗ 74,7 cm</p>	<p>---</p>
	<p><b>Memory foam mattress</b> Colchón viscoelástica Matelas viscoélastique Matratze aus Viscoschaum Materasso memory foam</p>	<p>ZV70-140</p> <p>↑ 12 cm → 140 cm ↗ 70 cm</p>	<p>ZC90-200</p> <p>↑ 22 cm → 200 cm ↗ 90 cm</p>
	<p><b>Small bolster pillow</b> Cojín redondo para Montessori Petit traversin Kleines Zylinderkissen Piccolo cuscino cilindrico</p>	<p>WCH-70</p> <p>⊙ 12 cm → 70 cm</p>	<p>WCH-90</p> <p>⊙ 12 cm → 90 cm</p>
	<p><b>Large bolster pillow</b> Cojín redondo para Montessori Grand traversin Großes Zylinderkissen Grande cuscino cilindrico</p>	<p>WCH-140</p> <p>⊙ 12 cm → 140 cm</p>	<p>---</p>

								
		<b>MINT</b> 055	<b>INDIANA BLU</b> 111	<b>INDIANA ROSA</b> 112	<b>ARROW</b> 140	<b>ARENA</b> 153	<b>CAREZZA</b> 178	<b>MARE</b> 181
<b>Canopy for Montessori beds</b> Toldo textil para cama Montessori Ciel de lit pour lits Montessori Bettimmel für Montessori-Betten Tendalino per letto Montessori	<b>HOMY</b> 70 x 140 	6140NA-055	6140NA-111	6140NA-112	6140NA-140	6140NA-153	6140NA-178	6140NA-181
	<b>HOMY XL</b> 90 x 200 	6200NA-055	6200NA-111	6200NA-112	6200NA-140	6200NA-153	6200NA-178	6200NA-181
	<b>INDY</b> 70 x 140 	6141NC-055	6141NC-111	6141NC-112	6141NC-140	6141NC-153	6141NC-178	6141NC-181

		<b>MINT</b> 055	<b>INDIANA BLU</b> 111	<b>INDIANA ROSA</b> 112	<b>ARROW</b> 140	<b>ARENA</b> 153	<b>CAREZZA</b> 178	<b>MARE</b> 181
<b>Duvet cover (with duvet)</b> Nórdico (con relleno) Housse et couette Bettbezug (mit Decke) Plumino nórdico (con imbottitura)	<b>626</b> 70 x 140 	626-055	626-111	626-112	626-140	626-153	626-178	626-181
	<b>636</b> 90 x 200 	636-055	636-111	636-112	636-140	636-153	636-178	636-181
<b>Duvet cover (without duvet)</b> Funda nórdica (sin relleno) Housse pour couette Bettbezug (ohne Decke) Sacco nórdico (senza imbottitura)	<b>626F</b> 70 x 140  (105 x 165 cm)	626F-055	626F-111	626F-112	626F-140	626F-153	626F-178	626F-181
	<b>636F</b> 90 x 200  (150 x 220 cm)	636F-055	636F-111	636F-112	636F-140	636F-153	636F-178	636F-181

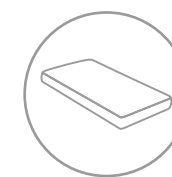
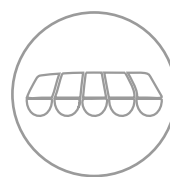

BABY  
70x140



Reference Referencia Référence Referenz Riferimento	Frame Estructura Structure Bettgestell Struttura	Canopy Toldo Ciel de lit Betthimmel Tendalino	Duvet cover (with duvet) Nórdico (con relleno) Housse et couette Bettbezug (mit Decke) Piumino nordico (con imbottitura)	Memory foam mattress Colchón viscoelástica Matelas viscoélastique Matratze aus Viscoschaum Materasso memory foam
HOMY-10	●	●		
HOMY-11	●		●	
HOMY-12	●		●	●
HOMY-13	●	●	●	
HOMY-14	●	●	●	●



INDY-10	●	●		
INDY-11	●		●	
INDY-12	●		●	●
INDY-13	●	●	●	
INDY-14	●	●	●	●

JUNIOR  
90x200



Reference Referencia Référence Referenz Riferimento	Frame Estructura Structure Bettgestell Struttura	Canopy Toldo Ciel de lit Betthimmel Tendalino	Duvet cover (with duvet) Nórdico (con relleno) Housse et couette Bettbezug (mit Decke) Piumino nordico (con imbottitura)	Memory foam mattress Colchón viscoelástica Matelas viscoélastique Matratze aus Viscoschaum Materasso memory foam
HOMY XL-20	●	●		
HOMY XL-21	●		●	
HOMY XL-22	●		●	●
HOMY XL-23	●	●	●	
HOMY XL-24	●	●	●	●



# KONVERS

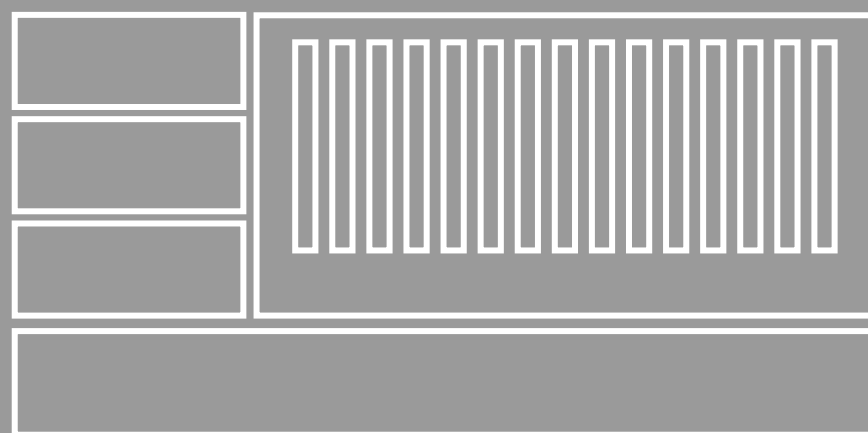

**CONVERTIBLE CRIBS | CUNAS CONVERTIBLES | LITS BÉBÉ ÉVOLUTIFS**  
*VERWANDELBARE BABYBETTEN | LETTINI TRASFORMABILI*



K379-M7700

JUST JOY **WHITE**



K379-M7778

JUST JOY **GREY**



K379-M7779

JUST JOY **ETNIK**



K379-M7781

JUST JOY **MARE**



K379-M7782

JUST JOY **ROSE**

2 STAGES | 2 ETAPAS | 2 ÉTAPES | 2 ETAPPEN | 2 FASI

BABY  
0-3  
years



Convertible crib | Cuna convertible  
Lit bébé évolutif | Verwandelbares Babybett  
Letino trasformabile



J370G-M7700 / J370M-M7700 +info page 55

Optional drawers | Cajones adicionales  
Tiroirs additionnels | Zusätzliche Schubladen  
Cassetti aggiuntivi

JUNIOR  
+3  
years



101,5 x 205,6 x 120 cm  
↑ → ↻

Convertible crib as bedroom | Cuna convertible desmontada como habitación  
Lit bébé évolutif transformé en chambre | Verwandelbares Babybett als Jugendzimmer  
Letino trasformabile montato a cameretta

60x120  
90x200

MATTE  
FINISH



K379-M7779  
60x 120 cm » 90x200 cm

101,5 x 173,2 x 65,4 cm  
↑ → ↻

## JUST JOY **ETNIK**



K376-M7700

JUST EVEN **WHITE**



K376-M7751

JUST EVEN **CIELO**



K376-M7752

JUST EVEN **CORAL**



K376-M7753

JUST EVEN **ARENA**



K376-M7778

JUST EVEN **GREY**

2 STAGES | 2 ETAPAS | 2 ÉTAPES | 2 ETAPPEN | 2 FASI

BABY  
0-3  
years



Convertible crib | Cuna convertible  
Lit bébé évolutif | Verwandelbares Babybett  
Letino trasformabile



J370G-M7700 / J370M-M7700 +info page 55

Optional drawers | Cajones adicionales  
Tiroirs additionnels | Zusätzliche Schubladen  
Cassetti aggiuntivi

JUNIOR  
+3  
years



Convertible crib as bedroom | Cuna convertible desmontada como habitación  
Lit bébé évolutif transformé en chambre | Verwandelbares Babybett als Jugendzimmer  
Letino trasformabile montato a cameretta

101,5 x 205,6 x 120 cm

60x120  
90x200

MATTE  
FINISH



## JUST EVEN MARE

K376-M7781  
60 x 120 cm » 90 x 200 cm

101,5 x 173,2 x 65,4 cm  
ⓘ Ⓜ Ⓝ



K374-M7700 JUST BUBBLE **WHITE**



K374-M7751 JUST BUBBLE **CIELO**



K374-M7752 JUST BUBBLE **CORAL**



K374-M7753 JUST BUBBLE **ARENA**



K374-M7778 JUST BUBBLE **GREY**

2 STAGES | 2 ETAPAS | 2 ÉTAPES | 2 ETAPPEN | 2 FASI



BABY  
0-3  
years

Convertible crib | Cuna convertible  
Lit bébé évolutif | Verwandelbares Babybett  
Lettino trasformabile



J370G-M7700 / J370M-M7700 +info page 55

Optional drawers | Cajones adicionales  
Tiroirs additionnels | Zusätzliche Schubladen  
Cassetti aggiuntivi



JUNIOR  
+3  
years

Convertible crib as bedroom | Cuna convertible desmontada como habitación  
Lit bébé évolutif transformé en chambre | Verwandelbares Babybett als Jugendzimmer  
Lettino trasformabile montato a cameretta

101,5 x 205,6 x 120 cm  
↑ → ↻

60x120  
90x200

MATTE  
FINISH



K374-M7755  
60 x 120 cm » 90 x 200 cm

101,5 x 173,2 x 65,4 cm  
↑ → ↻

## JUST BUBBLE MINT



Bed guard & stairs - toybox see page 54 | Barandilla junior y escalera-juguetero en la página 54  
Barrière junior et escalier - coffre à jouets voir page 54 | Gitter Junior und Treppe - Spielzeugkiste finden Sie auf der Seite 54  
Sponda junior e scaletta portagiochi a pagina 54



K559C-M7700  
Drawers | Cajones inferiores  
Tiroirs | Schubladen | Cassettoni

K559N-M7700  
Trundle bed | Cama nido  
Lit gigogne | Ausziehbett | Letto estraibile

SERO JOY **WHITE**



K559C-M7778  
Drawers | Cajones inferiores  
Tiroirs | Schubladen | Cassettoni

K559N-M7778  
Trundle bed | Cama nido  
Lit gigogne | Ausziehbett | Letto estraibile

SERO JOY **GREY**



K559C-M7779  
Drawers | Cajones inferiores  
Tiroirs | Schubladen | Cassettoni

K559N-M7779  
Trundle bed | Cama nido  
Lit gigogne | Ausziehbett | Letto estraibile

SERO JOY **ETNIK**



K559C-M7782  
Drawers | Cajones inferiores  
Tiroirs | Schubladen | Cassettoni

K559N-M7782  
Trundle bed | Cama nido  
Lit gigogne | Ausziehbett | Letto estraibile

SERO JOY **ROSE**

OPTIONS | OPCIONES | OPTIONS | OPTIONEN | OPZIONI



**Convertible crib with drawers**  
Cuna convertible con cajones inferiores  
Lit bébé évolutif avec tiroirs  
Verwandelbares Babybett mit Schubladen  
Lettino trasformabile con cassettoni



**Convertible crib with trundle bed**  
Cuna convertible con cama nido  
Lit bébé évolutif avec lit gigogne  
Verwandelbares Babybett mit Ausziehbett  
Lettino trasformabile con letto estraibile

3 STAGES | 3 ETAPAS | 3 ÉTAPES | 3 ETAPPEN | 3 FASI



BABY  
0-3  
years

**Convertible crib | Cuna convertible**  
Lit bébé évolutif | Verwandelbares Babybett  
Lettino trasformabile



KID  
3-5  
years

**With additional modules**  
Con módulos adicionales  
Avec des modules supplémentaires  
Mit Zusatzmodulen  
Con moduli aggiuntivi



JUNIOR  
+5  
years

**Convertible crib as bedroom**  
Cuna convertible desmontada como habitación  
Lit bébé évolutif transformé en chambre  
Verwandelbares Babybett als Jugendzimmer  
Lettino trasformabile montato a cameretta

37,5 x 206,4 x 102 cm

Junior bed | Cama junior | Lit | Bett | Letto



70x140  
90x200

MATTE  
FINISH



K559C-M7781  
Drawers | Cajones inferiores  
Tiroirs | Schubladen | Cassettoni

K559N-M7781  
Trundle bed | Cama nido  
Lit gigogne | Ausziehbett | Letto estraibile

105,5 x 206,4 x 102 cm  
① ② ③

70 x 140 cm » 90 x 200 cm

## SERO JOY MARE



Bed guard & stairs - toybox see page 54 | Barandilla junior y escalera-juguetero en la página 54  
Barrière junior et escalier - coffre à jouets voir page 54 | Gitter Junior und Treppe - Spielzeugkiste finden Sie auf der Seite 54  
Sponda junior e scaletta portagiochi a pagina 54



**K536C-M7751**  
Drawers | Cajones inferiores  
Tiroirs | Schubladen | Cassettoni  
**K536N-M7751**  
Trundle bed | Cama nido  
Lit gigogne | Ausziehbett | Letto estraibile

SERO EVEN **CIELO**



**K536C-M7752**  
Drawers | Cajones inferiores  
Tiroirs | Schubladen | Cassettoni  
**K536N-M7752**  
Trundle bed | Cama nido  
Lit gigogne | Ausziehbett | Letto estraibile

SERO EVEN **CORAL**



**K536C-M7753**  
Drawers | Cajones inferiores  
Tiroirs | Schubladen | Cassettoni  
**K536N-M7753**  
Trundle bed | Cama nido  
Lit gigogne | Ausziehbett | Letto estraibile

SERO EVEN **ARENA**



**K536C-M7778**  
Drawers | Cajones inferiores  
Tiroirs | Schubladen | Cassettoni  
**K536N-M7778**  
Trundle bed | Cama nido  
Lit gigogne | Ausziehbett | Letto estraibile

SERO EVEN **GREY**

3 STAGES | 3 ETAPAS | 3 ÉTAPES | 3 ETAPPEN | 3 FASI



**K536C-M7781**  
Drawers | Cajones inferiores  
Tiroirs | Schubladen | Cassettoni  
**K536N-M7781**  
Trundle bed | Cama nido  
Lit gigogne | Ausziehbett | Letto estraibile

SERO EVEN **MARE**



BABY  
0-3  
years

**Convertible crib | Cuna convertible**  
Lit bébé évolutif | Verwandelbares Babybett  
Lettino trasformabile



KID  
3-5  
years

**With additional modules**  
Con módulos adicionales  
Avec des modules supplémentaires  
Mit Zusatzmodulen  
Con moduli aggiuntivi



JUNIOR  
+5  
years

**Convertible crib as bedroom**  
Cuna convertible desmontada como habitación  
Lit bébé évolutif transformé en chambre  
Verwandelbares Babybett als Jugendzimmer  
Lettino trasformabile montato a cameretta

37,5 x 206,4 x 102 cm

Junior bed | Cama junior | Lit | Bett | Letto

70x140  
90x200

MATTE  
FINISH



K536C-M7700  
Drawers | Cajones inferiores  
Tiroirs | Schubladen | Cassettoni

K536N-M7700  
Trundle bed | Cama nido  
Lit gigogne | Ausziehbett | Letto estraibile

70x140 cm » 90x200 cm

105,5 x 206,4 x 102 cm  
↑ ↻ ↺

## SERO EVEN WHITE



Bed guard & stairs - toybox see page 54 | Barandilla junior y escalera-juguetero en la página 54  
Barrière junior et escalier - coffre à jouets voir page 54 | Gitter Junior und Treppe - Spielzeugkiste finden Sie auf der Seite 54  
Sponda junior e scaletta portagiochi a pagina 54



**K554C-M7700**  
Drawers | Cajones inferiores  
Tiroirs | Schubladen | Cassettoni  
**K554N-M7700**  
Trundle bed | Cama nido  
Lit gigogne | Ausziehbett | Letto estraibile

SERO BUBBLE **WHITE**



**K554C-M7751**  
Drawers | Cajones inferiores  
Tiroirs | Schubladen | Cassettoni  
**K554N-M7751**  
Trundle bed | Cama nido  
Lit gigogne | Ausziehbett | Letto estraibile

SERO BUBBLE **CIELO**



**K554C-M7752**  
Drawers | Cajones inferiores  
Tiroirs | Schubladen | Cassettoni  
**K554N-M7752**  
Trundle bed | Cama nido  
Lit gigogne | Ausziehbett | Letto estraibile

SERO BUBBLE **CORAL**



**K554C-M7753**  
Drawers | Cajones inferiores  
Tiroirs | Schubladen | Cassettoni  
**K554N-M7753**  
Trundle bed | Cama nido  
Lit gigogne | Ausziehbett | Letto estraibile

SERO BUBBLE **ARENA**



**K554C-M7778**  
Drawers | Cajones inferiores  
Tiroirs | Schubladen | Cassettoni  
**K554N-M7778**  
Trundle bed | Cama nido  
Lit gigogne | Ausziehbett | Letto estraibile

SERO BUBBLE **GREY**

3 STAGES | 3 ETAPAS | 3 ÉTAPES | 3 ETAPPEN | 3 FASI



BABY  
0-3  
years

**Convertible crib | Cuna convertible**  
Lit bébé évolutif | Verwandelbares Babybett  
Lettino trasformabile



KID  
3-5  
years

**With additional modules**  
Con módulos adicionales  
Avec des modules supplémentaires  
Mit Zusatzmodulen  
Con moduli aggiuntivi



JUNIOR  
+5  
years

**Convertible crib as bedroom**  
Cuna convertible desmontada como habitación  
Lit bébé évolutif transformé en chambre  
Verwandelbares Babybett als Jugendzimmer  
Lettino trasformabile montato a cameretta

37,5 x 206,4 x 102 cm  
Junior bed | Cama junior | Lit | Bett | Letto

CONVERTIBLE CRIBS | CUNAS CONVERTIBLES  
LITS BÉBÉ ÉVOLUTIFS | VERWANDELBARE BABYBETTEN | LETTINI TRASFORMABILI

# SERO BUBBLE

70x140  
90x200

MATTE  
FINISH



K554C-M7755  
Drawers | Cajones inferiores  
Tiroirs | Schubladen | Cassettoni

K554N-M7755  
Trundle bed | Cama nido  
Lit gigogne | Ausziehbett | Letto estraibile

105,5 x 206,4 x 102 cm  
↑ → ↻

70 x 140 cm » 90 x 200 cm

## SERO BUBBLE MINT



Bed guard & stairs - toybox see page 54 | Barandilla junior y escalera-juguetero en la página 54  
Barrière junior et escalier - coffre à jouets voir page 54 | Gitter Junior und Treppe - Spielzeugkiste finden Sie auf der Seite 54  
Sponda junior e scaletta portagiochi a pagina 54



Drawers | Cajones inferiores  
Tiroirs | Schubladen | Cassettoni

Trundle bed | Cama nido  
Lit gigogne | Ausziehbett | Letto estraibile

NEO *	K501C-G2300	K501N-G2300
NEO PLUS	K601C-G2300	K601N-G2300

## NEO MODULAR ARTIK



Drawers | Cajones inferiores  
Tiroirs | Schubladen | Cassettoni

Trundle bed | Cama nido  
Lit gigogne | Ausziehbett | Letto estraibile

NEO *	K501C-G2335	K501N-G2335
NEO PLUS	K601C-G2335	K601N-G2335

## NEO MODULAR PEARL

### 3 STAGES | 3 ETAPAS | 3 ÉTAPES | 3 ETAPPEN | 3 FASI

BABY  
0-3  
years



101,7 x 208,1 x 101,8 cm

Convertible crib | Cuna convertible  
Lit bébé évolutif | Verwandelbares Babybett  
Letto trasformabile

KID  
3-5  
years



101,7 x 208,1 x 101,8 cm

Convertible crib as cot with additional modules  
Cuna convertible montada con módulos adicionales  
Lit bébé évolutif avec des modules supplémentaires  
Verwandelbares Babybett als Kinderbett mit Zusatzmodulen  
Letto trasformabile montato con moduli aggiuntivi

JUNIOR  
+5  
years



101,7 x 208,1 x 101,8 cm

Junior bed | Cama junior  
Lit | Bett | Letto

Convertible crib as bedroom | Cuna convertible desmontada como habitación  
Lit bébé évolutif transformé en chambre | Verwandelbares Babybett als Jugendzimmer  
Letto trasformabile montato a cameretta

### NEO MODULAR \*

K501

Back view | Vista trasera | Vue arrière  
Rückwärtige Ansicht | Vista posteriore



Drawers | Cajones  
Tiroirs | Schubladen  
Cassettoni



Trundle bed | Cama nido  
Lit gigogne | Ausziehbett  
Letto estraibile



Bed base | Somier | Sommier  
Bettrost | Rete

Board bed base  
Somier de tablas  
Sommier en planche  
Bettrost: Platte  
Rete a pannelli

### NEO PLUS MODULAR \*\*

K601

Back view | Vista trasera | Vue arrière  
Rückwärtige Ansicht | Vista posteriore



Back board  
Tapa trasera  
Cache arrière  
Abdeckplatte  
Pannello posteriore



Bed base | Somier | Sommier  
Bettrost | Rete

Slatted bed base  
Somier de lattes  
Sommier à lattes  
Lattenrost  
Rete a doghe

70x140  
90x200

GLOSS  
FINISH



NEO \*

K501C-G2335

Drawers | Cajones inferiores  
Tiroirs | Schubladen | Cassettoni

K501N-G2335

Trundle bed | Cama nido  
Lit gigogne | Ausziehbett | Letto estraibile

NEO PLUS \*\*

K601C-G2335

Drawers | Cajones inferiores  
Tiroirs | Schubladen | Cassettoni

K601N-G2335

Trundle bed | Cama nido  
Lit gigogne | Ausziehbett | Letto estraibile

101,7 x 208,1 x 101,8 cm



70 x 140 cm » 90 x 200 cm

## NEO MODULAR PEARL

BABY  
0-3  
years



101,7 x 208,1 x 101,8 cm

**Convertible crib** | Cuna convertible  
Lit bébé évolutif | *Verwandelbares Babybett*  
Lettino trasformabile

KID  
3-5  
years



101,7 x 208,1 x 101,8 cm

**Convertible crib as cot with additional modules** | Cuna convertible montada con módulos adicionales  
Lit bébé évolutif avec des modules supplémentaires | *Verwandelbares Babybett als Kinderbett mit Zusatzmodulen*  
Lettino trasformabile montato con moduli aggiuntivi

JUNIOR  
+5  
years



101,7 x 208,1 x 101,8 cm

**Junior bed** | Cama junior  
Lit | Bett | Letto

**Convertible crib as junior bedroom** | Cuna convertible desmontada como habitación infantil | Lit bébé évolutif transformé en chambre junior  
*Verwandelbares Babybett als Jugendzimmer* | Lettino trasformabile montato a cameretta



70x140  
90x200

GLOSS  
FINISH



NEO \*

**K506C-G2335**  
Drawers | Cajones inferiores  
Tiroirs | Schubladen | Cassettoni

**K506N-G2335**  
Trundle bed | Cama nido  
Lit gigogne | Ausziehbett | Letto estraibile

NEO PLUS \*\*

**K606C-G2335**  
Drawers | Cajones inferiores  
Tiroirs | Schubladen | Cassettoni

**K606N-G2335**  
Trundle bed | Cama nido  
Lit gigogne | Ausziehbett | Letto estraibile

101,7 x 208,1 x 101,8 cm  
↑ → ↻

70x140cm » 90x200 cm

## NEO CLIP PEARL



Bed guard & stairs - toybox see page 54 | Barandilla junior y escalera-juguetero en la página 54  
Barrière junior et escalier - coffre à jouets voir page 54 | Gitter Junior und Treppe - Spielzeugkiste finden Sie auf der Seite 54  
Sponda junior e scaletta portagiochi a pagina 54



Drawers | Cajones inferiores  
Tiroirs | Schubladen | Cassettoni

Trundle bed | Cama nido  
Lit gigogne | Ausziehbett | Letto estraibile

NEO \* K506C-G2300 K506N-G2300

NEO PLUS \*\* K606C-G2300 K606N-G2300

NEO CLIP ARTIK



Drawers | Cajones inferiores  
Tiroirs | Schubladen | Cassettoni

Trundle bed | Cama nido  
Lit gigogne | Ausziehbett | Letto estraibile

NEO \* K506C-G2335 K506N-G2335

NEO PLUS \*\* K606C-G2335 K606N-G2335

NEO CLIP PEARL



Drawers | Cajones inferiores  
Tiroirs | Schubladen | Cassettoni

Trundle bed | Cama nido  
Lit gigogne | Ausziehbett | Letto estraibile

NEO \* K506C-G2353 K506N-G2353

NEO PLUS \*\* K606C-G2353 K606N-G2353

NEO CLIP ARENA



Drawers | Cajones inferiores  
Tiroirs | Schubladen | Cassettoni

Trundle bed | Cama nido  
Lit gigogne | Ausziehbett | Letto estraibile

NEO \* K506C-G2379 K506N-G2379

NEO PLUS \*\* K606C-G2379 K606N-G2379

NEO CLIP ETNIK

OPTIONS | OPCIONES | OPTIONS | OPTIONEN | OPZIONI



Convertible crib with drawers | Cuna convertibile con cajones inferiores  
Lit bébé évolutif avec tiroirs | Verwandelbares Babybett mit Schubladen  
Letto trasformabile con cassettoni



Convertible crib with trundle bed | Cuna convertibile con cama nido  
Lit bébé évolutif avec lit gigogne | Verwandelbares Babybett mit Ausziehbett  
Letto trasformabile con letto estraibile



Drawers | Cajones inferiores  
Tiroirs | Schubladen | Cassettoni

Trundle bed | Cama nido  
Lit gigogne | Ausziehbett | Letto estraibile

NEO \* K506C-G2351 K506N-G2351

NEO PLUS K606C-G2351 K606N-G2351

## NEO CLIP CIELO



Drawers | Cajones inferiores  
Tiroirs | Schubladen | Cassettoni

Trundle bed | Cama nido  
Lit gigogne | Ausziehbett | Letto estraibile

NEO \* K506C-G2352 K506N-G2352

NEO PLUS K606C-G2352 K606N-G2352

## NEO CLIP CORAL



Drawers | Cajones inferiores  
Tiroirs | Schubladen | Cassettoni

Trundle bed | Cama nido  
Lit gigogne | Ausziehbett | Letto estraibile

NEO \* K506C-G2381 K506N-G2381

NEO PLUS K606C-G2381 K606N-G2381

## NEO CLIP MARE



Drawers | Cajones inferiores  
Tiroirs | Schubladen | Cassettoni

Trundle bed | Cama nido  
Lit gigogne | Ausziehbett | Letto estraibile

NEO \* K506C-G2392 K506N-G2392

NEO PLUS K606C-G2392 K606N-G2392

## NEO CLIP COCO

### NEO CLIP \*



Back view | Vista trasera  
Vue arrière | Rückwärtige Ansicht  
Vista posteriore



Board bed base | Sommier de tablas  
Sommier en planche | Bettrost: Platte  
Rete a pannelli

### NEO PLUS CLIP \*\*



Back view - Back board | Vista trasera - Tapa trasera  
Vue arrière - Cache arrière | Rückwärtige Ansicht - Abdeckplatte  
Vista posteriore - Pannello posteriore



Slatted bed base | Sommier de lamas  
Sommier à lattes | Lattenrost  
Rete a doghe

BABY  
0-3  
años



103,4 x 214,1 x 101,8 cm

**Convertible crib** | Cuna convertible  
Lit bébé évolutif | *Verwandelbares Babybett*  
Letino trasformabile

KID  
3-5  
años



103,4 x 214,1 x 101,8 cm

**Convertible crib as cot with additional modules** | Cuna convertible montada con módulos adicionales  
Lit bébé évolutif avec des modules supplémentaires | *Verwandelbares Babybett als Kinderbett mit Zusatzmodulen*  
Letino trasformabile montato con moduli aggiuntivi

JUNIOR  
+5  
años



101,7 x 214,1 x 101,8 cm

**Junior bed** | Cama junior  
Lit | Bett | Letto

**Convertible crib as junior bedroom** | Cuna convertible desmontada como habitación infantil | Lit bébé évolutif transformé en chambre junior  
*Verwandelbares Babybett als Jugendzimmer* | Letino trasformabile montato a cameretta

CONVERTIBLE CRIBS | CUNAS CONVERTIBLES  
LITS BÉBÉ ÉVOLUTIFS | VERWANDELBARE BABYBETTEN | LETTINI TRASFORMABILI

# PREMIUM KURVE

MATTE  
FINISH

103,4 x 214,1 x 101,8 cm



K417CR-M7700

Drawers | Cajones inferiores

Tiroirs | Schubladen | Cassettoni

70 x 140 cm » 90 x 200 cm





Bed guard & stairs - toybox see page 54 | Barandilla junior y escalera-juguetero en la página 54  
Barrière junior et escalier - coffre à jouets voir page 54 | Gitter Junior und Treppe - Spielzeugkiste finden Sie auf der Seite 54  
Sponda junior e scaletta portagiochi a pagina 54



**Dropside on the right** | Barandilla montada a la derecha  
Barrière à droite | Gitter auf der rechten Seite  
Sponda montata a destra

**Drawers** | Cajones inferiores  
Tiroirs | Schubladen | Cassettoni  
K417CR-M7700

**Trundle bed** | Cama nido  
Lit gigogne | Ausziehbett | Letto estraibile  
K417NR-M7700

**Dropside on the left** | Barandilla montada a la izquierda  
Barrière à gauche | Gitter auf der linken Seite  
Sponda montata a sinistra

K417CL-M7700

K417NL-M7700

## KURVE WHITE



**Dropside on the right** | Barandilla montada a la derecha  
Barrière à droite | Gitter auf der rechten Seite  
Sponda montata a destra

**Drawers** | Cajones inferiores  
Tiroirs | Schubladen | Cassettoni  
K417CR-M7778

**Trundle bed** | Cama nido  
Lit gigogne | Ausziehbett | Letto estraibile  
K417NR-M7778

**Dropside on the left** | Barandilla montada a la izquierda  
Barrière à gauche | Gitter auf der linken Seite  
Sponda montata a sinistra

K417CL-M7778

K417NL-M7778

## KURVE GREY



**Dropside on the right** | Barandilla montada a la derecha  
Barrière à droite | Gitter auf der rechten Seite  
Sponda montata a destra

**Drawers** | Cajones inferiores  
Tiroirs | Schubladen | Cassettoni  
K417CR-M7791

**Trundle bed** | Cama nido  
Lit gigogne | Ausziehbett | Letto estraibile  
K417NR-M7791

**Dropside on the left** | Barandilla montada a la izquierda  
Barrière à gauche | Gitter auf der linken Seite  
Sponda montata a sinistra

K417CL-M7791

K417NL-M7791

## KURVE NATURE



**Dropside on the right** | Barandilla montada a la derecha  
Barrière à droite | Gitter auf der rechten Seite  
Sponda montata a destra

**Drawers** | Cajones inferiores  
Tiroirs | Schubladen | Cassettoni  
K417CR-M7792

**Trundle bed** | Cama nido  
Lit gigogne | Ausziehbett | Letto estraibile  
K417NR-M7792

**Dropside on the left** | Barandilla montada a la izquierda  
Barrière à gauche | Gitter auf der linken Seite  
Sponda montata a sinistra

K417CL-M7792

K417NL-M7792

## KURVE COCO

**WITH DRAWERS | OPCIÓN CON CAJONES**

OPTION AVEC TIROIRS | MIT SCHUBLADEN | OPZIONE CON CASSETTONI



**Convertible crib with drawers** | Cuna convertible con cajones inferiores  
Lit bébé évolutif avec tiroirs | *Verwandelbares Babybett mit Schubladen* | Lettino trasformabile con cassettoni

**WITH TRUNDLE BED | OPCIÓN CON CAMA NIDO**

OPTION AVEC LIT GIGOGNE | MIT AUSZIEHBETT | OPZIONE CON LETTO ESTRAIBILE



**Convertible crib with trundle bed** | Cuna convertible con cama nido  
Lit bébé évolutif avec lit gigogne | *Verwandelbares Babybett mit Ausziehbett* | Lettino trasformabile con letto estraibile

**ASSEMBLY ON THE RIGHT | MONTAJE A DERECHA**

MONTAGE À DROITE | *AUFBAU RECHTS* | MONTAGGIO A DESTRA



**Dropside on the right** | Barandilla montada a la derecha  
Barrière à droite | *Gitter auf der rechten Seite*  
Sponda montata a destra

**ASSEMBLY ON THE LEFT | MONTAJE A IZQUIERDA**

MONTAGE À GAUCHE | *AUFBAU LINKS* | MONTAGGIO A SINISTRA



**Dropside on the left** | Barandilla montada a la izquierda  
Barrière à gauche | *Gitter auf der linken Seite*  
Sponda montata a sinistra

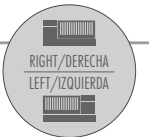

**JB400** Bed guard | Barandilla junior | Barrière junior | Gitter Junior | Sponda junior

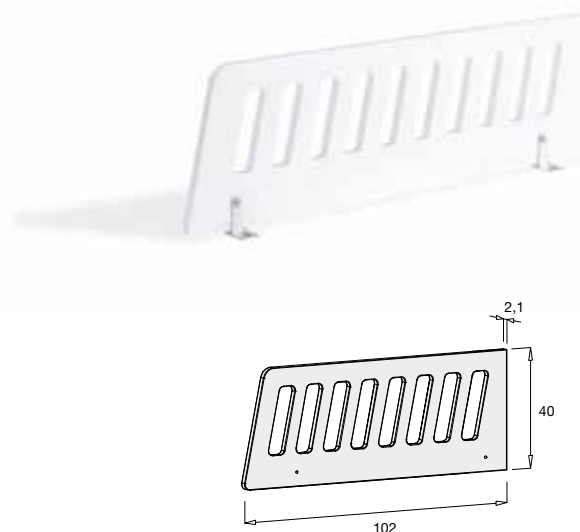

Reference Referencia Référence Referenz Riferimento	Colour Color Couleur Farbe Colore
<b>JB400-G23</b>	<b>Gloss white</b> Blanco brillo Blanc brillant Weiss glanz Bianco lucido
<b>JB400-M77</b>	<b>Matte white</b> Blanco mate Blanc mat Weiss matt Bianco opaco

Compatible with Konvers ranges  
Compatible with los Konvers  
Compatible avec les gammes Konver  
Kompatibel für die Konvers  
Compatibile con Konvers

**NEO - NEO PLUS - PREMIUM KURVE**

**JB502** Bed guard | Barandilla junior | Barrière junior | Gitter Junior | Sponda junior

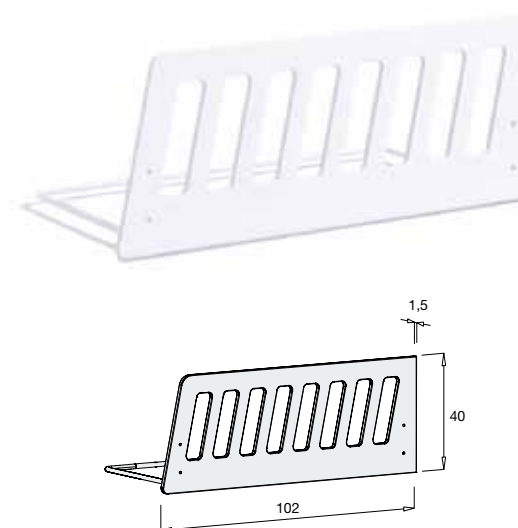

Reference Referencia Référence Referenz Riferimento	Colour Color Couleur Farbe Colore
<b>JB502-G23</b>	<b>Gloss white</b> Blanco brillo Blanc brillant Weiss glanz Bianco lucido
<b>JB502-M77</b>	<b>Matte white</b> Blanco mate Blanc mat Weiss matt Bianco opaco

Compatible with all Alondra 70x140 convertible cribs  
Compatible con todos los Konvers de 70x140 de Alondra  
Compatible avec tous les lits évolutifs Alondra en 70x140  
Kompatibel für alle Alondra Konvers mit den Massen 70x140  
Compatibile con tutti i Konvers Alondra di 70x140

**JU400** Stairs - toybox | Escalera-juguetero | Escalier - coffre à jouets | Treppe - Spielzeugkiste | Scaletta portagiochi

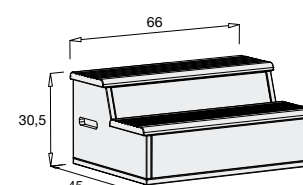

Reference Referencia Référence Referenz Riferimento	Colour Color Couleur Farbe Colore
<b>JU400-G23</b>	<b>Gloss white</b> Blanco brillo Blanc brillant Weiss glanz Bianco lucido
<b>JU400-M77</b>	<b>Matte white</b> Blanco mate Blanc mat Weiss matt Bianco opaco

Compatible with all Alondra 70x140 convertible cribs  
Compatible con todos los Konvers de 70x140 de Alondra  
Compatible avec tous les lits évolutifs Alondra en 70x140  
Kompatibel für alle Alondra Konvers mit den Massen 70x140  
Compatibile con tutti i Konvers Alondra di 70x140



# ACCESSORIES

## J370G / J370M Additional drawers | Cajones inferiores | Tiroirs additionnels | Zusätzliche Schubladen | Cassetti inferiori



Compatible with the Konver range | Compatible con los Konvers  
Compatible avec la gamme Konver | Kompatibel für den Konvers  
Compatibile con Konvers

JUST

### J370G-M7700

Large drawer | Cajón grande | Grand tiroir  
Große Schublade | Cassetto grande

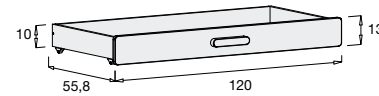

### J370M-M7700

Small drawer | Cajón pequeño | Petit tiroir  
Kleine Schublade | Cassetto piccolo

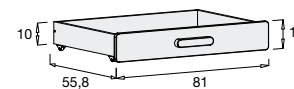

Optional drawers ref. J370G and J370M can only be used under the junior bed (not compatible with the cot during the BABY stage).

Los cajones opcionales J370G y J370M únicamente se pueden poner bajo la cama junior, nunca bajo la cuna en la etapa BABY.

Les tiroirs supplémentaires réf. J370G et J370M ne peuvent être utilisés qu'en dessous du lit junior (pas compatibles avec le lit évolutif pendant l'étape BABY).

Die optionalen Schubladen Ref. J370G und J370M können nur mit dem Jugendbett genutzt werden, niemals mit dem Babybett.

I cassetti aggiuntivi J370G e J370M possono essere collocati solo sotto il letto da 90x200 derivante dalla trasformazione del lettino. NON compatibile con il Konver JUST montato in fase BABY.

## V656 Changer support | Soporte vestidor | Support commode à langer Wickelaufsatz | Supporto fasciatoio cassettiere

### STAGE 1 | ETAPA 1 | ÉTAPE 1 ETAPPE 1 | FASE 1



### STAGE 2 | ETAPA 2 | ÉTAPE 2 ETAPPE 2 | FASE 2



### Sideways | Posición lateral Position latérale | Seitlich Vista laterale

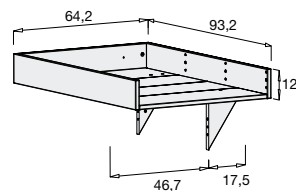

### Frontal | Posición frontal Position frontale | Frontal Vista frontale

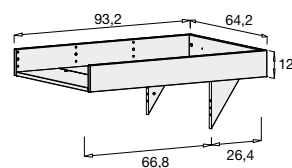

Compatible with the chest ranges | Compatible con las cómodas  
Compatible avec les commodes | Kompatibel für die Kommoden  
Compatibile con cassettiere

CLIP · EVEN · MODULAR · PREMIUM

### Shelf Estantería Étagère murale Regal Mensola

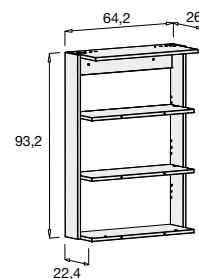

Reference Referencia Référence Referenz Riferimento	Colour Color Couleur Farbe Colore
V656-G2300	Gloss white Blanco brillo Blanc brillant Weiss glanz Bianco lucido
V656-M7700	Matte white Blanco mate Blanc mat Weiss matt Bianco opaco

V656-M7700

## V657 Changer support | Soporte vestidor | Support commode à langer Wickelaufsatz | Supporto fasciatoio cassettiere

### STAGE 1 | ETAPA 1 | ÉTAPE 1 ETAPPE 1 | FASE 1



### STAGE 2 | ETAPA 2 | ÉTAPE 2 ETAPPE 2 | FASE 2



### Sideways | Posición lateral Position latérale | Seitlich Vista laterale

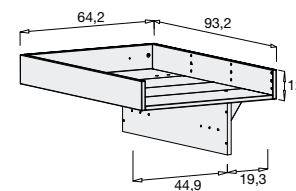

### Frontal | Posición frontal Position frontale | Frontal Vista frontale

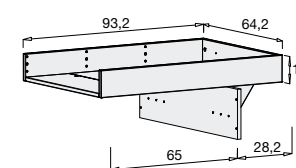

Compatible with the chest ranges | Compatible con las cómodas  
Compatible avec les commodes | Kompatibel für die Kommoden  
Compatibile con cassettiere

BUBBLE · JOY

### Shelf Estantería Étagère murale Regal Mensola

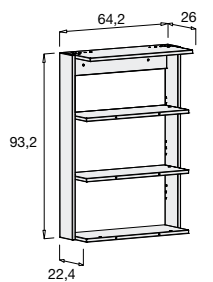

Reference Referencia Référence Referenz Riferimento	Colour Color Couleur Farbe Colore
V657-G2300	Gloss white Blanco brillo Blanc brillant Weiss glanz Bianco lucido
V657-M7700	Matte white Blanco mate Blanc mat Weiss matt Bianco opaco

V657-M7700



# BABY FURNITURE

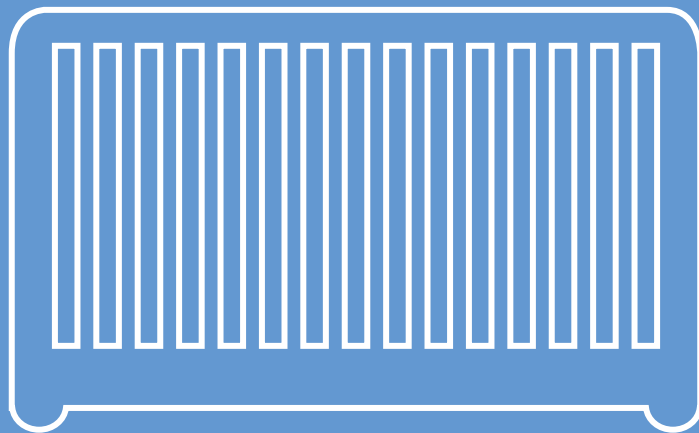

**BABY FURNITURE | MOBILIARIO INFANTIL | MOBILIER BÉBÉ**  
*BABYMÖBEL | MOBILI PER BAMBINI*

**Wardrobes | Armarios | Armoires | Schränke | Armadi**

**Chests | Cómodos | Commodes | Kommoden | Cassettiere**



**V657-M7700**  
**Optional changer support**  
 Soporte vestidor opcional  
 Plan à langer supplémentaire  
 Zusätzlicher Wickelaufsatz  
 Supporto fasciatoio supplementare

**A359G**

↑ 204,8 cm → 120 cm ↻ 61,6 cm

- A359G-M7700
- A359G-M7778
- A359G-M7779
- A359G-M7781
- A359G-M7782

**A359**

↑ 204,8 cm → 80 cm ↻ 61,6 cm

- A359-M7700
- A359-M7778
- A359-M7779
- A359-M7781
- A359-M7782

**D259G**

↑ 84,8 cm → 120 cm ↻ 61,6 cm

- D259G-M7700
- D259G-M7778
- D259G-M7779
- D259G-M7781
- D259G-M7782

**D259C**

↑ 84,8 cm → 80 cm ↻ 61,6 cm

- D259C-M7700
- D259C-M7778
- D259C-M7779
- D259C-M7781
- D259C-M7782

**D259**

↑ 84,8 cm → 80 cm ↻ 61,6 cm

- D259-M7700
- D259-M7778
- D259-M7779
- D259-M7781
- D259-M7782

**60 x 120 cm**  
**Cots | Cunas | Lits bébé | Babybetten | Lettini**

**70 x 140 cm**  
**Cots | Cunas | Lits bébé | Babybetten | Lettini**

**Bath changers | Bañeras**  
 Bañoires | *Waschtische* | Bagnetti



**Cot 60x120 | Cuna 60x120 | Lit bébé 60x120**  
*Babybett 60x120 | Lettino 60x120*

**Cot 70x140 | Cuna 70x140 | Lit bébé 70x140**  
*Babybett 70x140 | Lettino 70x140*

**Toddler bed | Cama infantil | Lit cadet**  
*Kinderbett | Lettino sponda junior*

**C150**

↑ 80 cm → 132 cm ↻ 64 cm

- C150-M7700
- C150-M7778
- C150-M7779
- C150-M7781
- C150-M7782

**C160**

↑ 79,5 cm → 150 cm ↻ 74,1 cm

- C160-M7700
- C160-M7778
- C160-M7779
- C160-M7781
- C160-M7782

**B759**

↑ 93 cm → 79 cm ↻ 49 cm

- B759-M7700
- B759-M7778
- B759-M7779
- B759-M7781
- B759-M7782

**60 x 120 cm**  
**Co-sleeping cot | Cuna de colecho | Lit bébé cododo | Beistellbett | Lettino fianco letto**



**Co-sleeping cot | Cuna de colecho**  
 Lit bébé cododo | *Beistellbett*  
 Lettino fianco letto

**Cot 60x120 | Cuna 60x120**  
 Lit bébé 60x120 | *Babybett 60x120*  
 Lettino 60x120

**Toddler bed | Cama infantil**  
 Lit cadet | *Juniorbett*  
 Lettino sponda junior

**Couch | Sofá infantil**  
 Canapé | *Sofa*  
 Divanetto

**Desk | Escritorio infantil**  
 Bureau | *Schreibtisch*  
 Scrivania

**C181**

↑ 91 cm → 126 cm ↻ 72,9 cm

- C181-M7700
- C181-M7778

\* +info pages 10-21  
**5 stages with additional kits or accessories**  
 5 etapas con packs o accesorios adicionales  
 5 étapes avec des kits ou accessoires supplémentaires  
 5 Etappen mit zusätzlichen Kits oder Zubehör  
 5 fasi con packs o accessori opzionali



D259G-M7779

A359G-M7779

C150-M7779  
60 x 120 cm



JOY WHITE



JOY GREY



JOY ETNIK



JOY ROSE

MATTE  
FINISH



A359G-M7781

C150-M7781  
60x120 cm



D259-M7781

## JOY MARE

**Wardrobes | Armarios | Armoires | Schränke | Armadi**

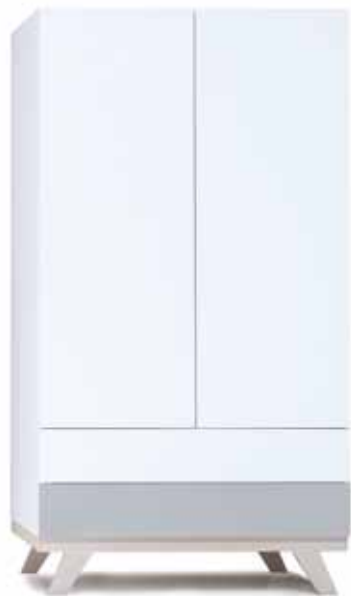

**Close-up of the feet**  
 Detalle de la pata del mueble  
 Vue rapprochée du pied  
 Detailansicht der Möbelfüsse  
 Particolare del piedino del mobile

**A336**

↑ 202,2 cm → 108,2 cm ↻ 61,8 cm

- A336-M7700
- A336-M7751
- A336-M7752
- A336-M7753
- A336-M7778
- A336-M7781

**Chests | Cómicas | Commodes | Kommoden | Cassettiere**



V656-M7700

**Optional changer support**  
 Soporte vestidor opcional  
 Plan à langer supplémentaire  
 Zusätzlicher Wickelaufsatz  
 Supporto fasciatoio supplementare



**D236**

↑ 95 cm → 108,2 cm ↻ 51,5 cm

- D236-M7700
- D236-M7751
- D236-M7752
- D236-M7753
- D236-M7778
- D236-M7781

**60 x 120 cm**

**Cots | Cunas | Lits bébé | Babybetten | Lettini**



**Cot 60x120 | Cuna 60x120 | Lit bébé 60x120**  
*Babybett 60x120 | Lettino 60x120*

**C150**

↑ 80 cm → 132 cm ↻ 64 cm

- C150-M7700
- C150-M7751
- C150-M7752
- C150-M7753
- C150-M7778
- C150-M7781

**70 x 140 cm**

**Cots | Cunas | Lits bébé | Babybetten | Lettini**



**Cot 70x140 | Cuna 70x140 | Lit bébé 70x140**  
*Babybett 70x140 | Lettino 70x140*

**C160**

↑ 79,5 cm → 150 cm ↻ 74,1 cm

- C160-M7700
- C160-M7751
- C160-M7752
- C160-M7753
- C160-M7778
- C160-M7781



**Toddler bed | Cama infantil | Lit cadet**  
*Kinderbett | Lettino sponda junior*

**60 x 120 cm**

**Co-sleeping cot | Cuna de colecho | Lit bébé cododo | *Beistellbett* | Lettino fianco letto**



**Co-sleeping cot | Cuna de colecho**  
 Lit bébé cododo | *Beistellbett*  
 Lettino fianco letto



**Cot 60x120 | Cuna 60x120**  
 Lit bébé 60x120 | *Babybett 60x120*  
 Lettino 60x120



**Toddler bed | Cama infantil**  
 Lit cadet | *Juniorbett*  
 Lettino sponda junior



**Couch | Sofá infantil**  
 Canapé | *Sofa*  
 Divanetto



**Desk | Escritorio infantil**  
 Bureau | *Schreibtisch*  
 Scrivania

**C181**

↑ 91 cm → 126,1 cm ↻ 72,9 cm

- C181-M7700
- C181-M7751
- C181-M7752
- C181-M7753
- C181-M7778

\* +info pages 10-21  
**5 stages with additional kits or accessories**  
 5 etapas con packs o accesorios adicionales  
 5 étapes avec des kits ou accessoires supplémentaires  
 5 Etappen mit zusätzlichen Kits oder Zubehör  
 5 fasi con packs o accessori opzionali



MATTE  
FINISH



D236-M7778

A336-M7778

C150-M7778  
60x120 cm

## EVEN GREY



EVEN **WHITE**



EVEN **CIELO**



EVEN **ARENA**



EVEN **MARE**

MATTE  
FINISH



D236-M7752



C150-M7752  
60x120cm



A336-M7752

## EVEN CORAL



**Wardrobes | Armarios | Armoires | Schränke | Armadi**

**Chests | Cómodos | Commodes | Kommoden | Cassettiere**



V657-M7700

**Optional changer support**  
 Soporte vestidor opcional  
 Plan à langer supplémentaire  
 Zusätzlicher Wickelaufsatz  
 Supporto fasciatoio supplementare

**A354G**

↑ 204,8 cm → 120 cm ↻ 61,6 cm

- A354G-M7700
- A354G-M7751
- A354G-M7752
- A354G-M7753
- A354G-M7755
- A354G-M7778

**A354**

↑ 204,8 cm → 80 cm ↻ 61,6 cm

- A354-M7700
- A354-M7751
- A354-M7752
- A354-M7753
- A354-M7755
- A354-M7778

**D254G**

↑ 84,8 cm → 120 cm ↻ 61,6 cm

- D254G-M7700
- D254G-M7751
- D254G-M7752
- D254G-M7753
- D254G-M7755
- D254G-M7778

**D254C**

↑ 84,8 cm → 80 cm ↻ 61,6 cm

- D254C-M7700
- D254C-M7751
- D254C-M7752
- D254C-M7753
- D254C-M7755
- D254C-M7778

**D254**

↑ 84,8 cm → 80 cm ↻ 61,6 cm

- D254-M7700
- D254-M7751
- D254-M7752
- D254-M7753
- D254-M7755
- D254-M7778

**60 x 120 cm**  
**Cots | Cunas | Lits bébé | Babybetten | Lettini**

**70 x 140 cm**  
**Cots | Cunas | Lits bébé | Babybetten | Lettini**

**Bath changers | Bañeras**  
 Bañoires | *Waschtische* | Bagnetti



**Cot 60x120 | Cuna 60x120 | Lit bébé 60x120**  
*Babybett 60x120 | Lettino 60x120*

**Cot 70x140 | Cuna 70x140 | Lit bébé 70x140**  
*Babybett 70x140 | Lettino 70x140*

**Toddler bed | Cama infantil | Lit cadet**  
*Kinderbett | Lettino sponda junior*

**C150**

↑ 80 cm → 132 cm ↻ 64 cm

- C150-M7700
- C150-M7751
- C150-M7752
- C150-M7753
- C150-M7755
- C150-M7778

**C160**

↑ 79,5 cm → 150 cm ↻ 74,1 cm

- C160-M7700
- C160-M7751
- C160-M7752
- C160-M7753
- C160-M7755
- C160-M7778

**B754**

↑ 93 cm → 79 cm ↻ 49 cm

- B754-M7700
- B754-M7751
- B754-M7752
- B754-M7753
- B754-M7755
- B754-M7778

**60 x 120 cm**  
**Co-sleeping cot | Cuna de colecho | Lit bébé cododo | *Beistellbett* | Lettino fianco letto**



**Co-sleeping cot | Cuna de colecho**  
 Lit bébé cododo | *Beistellbett*  
 Lettino fianco letto

**Cot 60x120 | Cuna 60x120**  
 Lit bébé 60x120 | *Babybett 60x120*  
 Lettino 60x120

**Toddler bed | Camita infantil**  
 Lit cadet | *Juniorbett*  
 Lettino sponda junior

**Couch | Sofá infantil**  
 Canapé | *Sofa*  
 Divanetto

**Desk | Escritorio infantil**  
 Bureau | *Schreibtisch*  
 Scrivania

**C181**

↑ 91 cm → 126 cm ↻ 72,9 cm

- C181-M7700
- C181-M7751
- C181-M7752
- C181-M7753
- C181-M7755
- C181-M7778

+info pages 10-21

**5 stages with additional kits or accessories | 5 etapas con packs o accesorios adicionales**  
 5 étapes avec des kits ou accessoires supplémentaires | *5 Etappen mit zusätzlichen Kits oder Zubehör* | 5 fasi con packs o accessori opzionali

# BUBBLE

MATTE  
FINISH



D254G-M7778

A354G-M7778

C150-M7778  
60 x 120 cm

## BUBBLE GREY



BUBBLE **WHITE**



BUBBLE **CIELO**



BUBBLE **CORAL**



BUBBLE **ARENA**

# BUBBLE

MATTE  
FINISH



D254G-M7755



C150-M7755  
60x 120 cm



A354G-M7755

BUBBLE MINT



**Wardrobes | Armarios | Armoires | Schränke | Armadi**

**Chests | Cómодas | Commodes | Kommoden | Cassettiere**



V656-G2300

**Optional changer support**  
 Soporte vestidor opcional  
 Plan à langer supplémentaire  
 Zusätzlicher Wickelaufsatz  
 Supporto fasciatoio supplementare

**A3016**

↑ 200 cm → 150 cm ↻ 59,8 cm

▫ A3016-G2300  
 ▫ A3016-G2335

**A3014**

↑ 200 cm → 100 cm ↻ 59,8 cm

▫ A3014-G2300  
 ▫ A3014-G2335

**D20132**

↑ 91 cm → 141 cm ↻ 48,8 cm

▫ D20132-G2300  
 ▫ D20132-G2335

**D20121**

↑ 91 cm → 94 cm ↻ 48,8 cm

▫ D20121-G2300  
 ▫ D20121-G2335

**60 x 120 cm**

**Cots | Cunas | Lits bébé | Babybetten | Lettini**

**70 x 140 cm**

**Cots | Cunas | Lits bébé | Babybetten | Lettini**



**Cot 60x120 | Cuna 60x120 | Lit bébé 60x120**  
*Babybett 60x120 | Lettino 60x120*

**C150**

↑ 80 cm → 132 cm ↻ 64 cm

▫ C150-G2300  
 ▫ C150-G2335

**Cot 70x140 | Cuna 70x140 | Lit bébé 70x140**  
*Babybett 70x140 | Lettino 70x140*

**C160**

↑ 79,5 cm → 150 cm ↻ 74,1 cm

▫ C160-G2300  
 ▫ C160-G2335

**Toddler bed | Cama infantil | Lit cadet**  
*Kinderbett | Lettino sponda junior*



# MODULAR

GLOSS  
FINISH



D20132-G2300

A3016-G2300

C150-G2300  
60x120 cm

MODULAR **ARTIK**



### D201C

↑ 88,3 cm → 47 cm ↗ 48,8 cm

**Modular chest with 4 drawers (without countertop)**  
**Cómoda modular con 4 cajones (sin tapa)**  
 Commode modulaire avec 4 tiroirs (sans partie supérieure)  
 Modulare Kommode mit 4 Schubladen (ohne Abdeckplatte)  
 Cassettiera modulare con 4 cassetti (senza copertura)

◐ D201C-G2300

◑ D201C-G2335

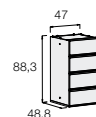

### D201E

↑ 88,3 cm → 47 cm ↗ 48,8 cm

**Modular chest with 2 shelves (without countertop)**  
**Cómoda modular con 2 estantes (sin tapa)**  
 Commode modulaire avec 2 étagères (sans partie supérieure)  
 Modulare Kommode mit 2 Einlegeböden (ohne Abdeckplatte)  
 Cassettiera modulare con 2 ripiani (senza copertura)

◐ D201E-G2300

◑ D201E-G2335

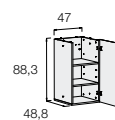

### WT201 / WT201L

↑ 1,9 cm → 47 cm ↗ 47 cm

**Countertop for 1 module**  
**Tapa para 1 módulo de cómoda**  
 Partie supérieure pour 1 module  
 Abdeckplatte für 1 Modul  
 Copertura per 1 modulo cassettiera

◐ WT201-G30

◑ WT201L-G2300

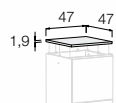

### WT202 / WT202L

↑ 1,9 cm → 94 cm ↗ 47 cm

**Countertop for 2 modules**  
**Tapa para 2 módulos de cómoda**  
 Partie supérieure pour 2 modules  
 Abdeckplatte für 2 Module  
 Copertura per 2 moduli cassettiera

◐ WT202-G30

◑ WT202L-G2300

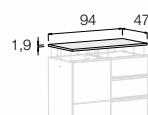

### WT203 / WT203L

↑ 1,9 cm → 141 cm ↗ 47 cm

**Countertop for 3 modules**  
**Tapa para 3 módulos de cómoda**  
 Partie supérieure pour 3 modules  
 Abdeckplatte für 3 Module  
 Copertura per 3 moduli cassettiera

◐ WT203-G30

◑ WT203L-G2300

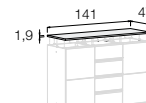

In order to build any modular chest (D201C and D201E), it is necessary to purchase a countertop depending on the number of modules (available for 1, 2 and 3 modules). The price of the chest does not include the top.

Para comprar cualquier módulo de cómoda modular D201C y D201E se deberá pedir necesariamente la tapa/encimera según los módulos que desee, disponible para 1, 2 y 3 módulos. El precio del módulo no incluye el de la tapa/encimera.

Pour compléter les modules D201C et D201E, il faudra rajouter la planche supérieure. Disponible pour 1, 2 et 3 modules. Le dessus n'est pas inclus dans le prix du module.

Für jede modulare Kommode (D201C und D201E) muss immer eine obere Abdeckplatte gekauft werden (verfügbar für 1, 2, 3 Module). Der Preis der Kommode schließt die Abdeckplatte nicht ein.

Per comporre una cassettiera modulare con i moduli D201C e D201E, si dovrà acquistare necessariamente l'apposito pannello/copertura, disponibile per 1, 2 o 3 moduli, in base alla composizione che si vuole fare. Il pannello/copertura non è compreso nel prezzo del modulo.



The modular chests include small adjustable feet, which allow to even the chest when placed on uneven floors (min 7mm - max. 11mm).

Las cómodas modulares incorporan un sistema de pequeñas patas regulables en altura que permite nivelar la cómoda cuando se colocan sobre suelos irregulares (evitando también futuros problemas de humedad).  
 Mín. 7mm - Máx. 11mm.

La commode modulaire inclut un système de petits pieds réglables (min. 7mm - max. 11mm), qui permettent de niveler la commode si le sol n'est pas complètement droit.

Die modulare Kommode integriert kleine anpassbare Füße, die eine Nivellierung der Kommode ermöglichen (7mm min - max. 11mm).

Le cassetteiere modulari includono un sistema di piedini regolabili in altezza che permettono di livellarle quando il pavimento presenta delle irregolarità, aumentando la sua altezza di un minimo di 7 mm (evitando inoltre eventuali accumuli di umidità).  
 Min. 7 mm. - Max. 11 mm.

# MODULAR SYSTEM



**A301B**

↑ 100 cm → 50 cm ↗ 59,8 cm

**Modular wardrobe with hanging rod**  
 Armario modular con barra para colgar  
 Armoire modulaire avec penderie  
 Modulschrank mit Kleiderstange  
 Armadio modulare con barra appendiabiti

□ A301B-G2300  
 ■ A301B-G2335



**A301C**

↑ 100 cm → 50 cm ↗ 59,8 cm

**Modular wardrobe with 4 drawers**  
 Armario modular con 4 cajones  
 Armoire modulaire avec 4 tiroirs  
 Modulschrank mit 4 Schubladen  
 Armadio modulare con 4 cassetti

□ A301C-G2300  
 ■ A301C-G2335

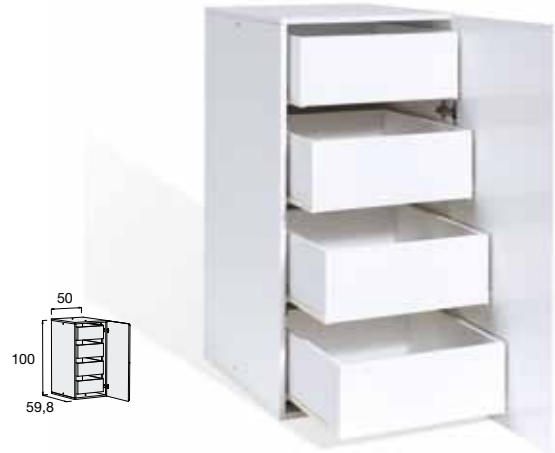

**A301E**

↑ 100 cm → 50 cm ↗ 59,8 cm

**Modular wardrobe with 2 shelves**  
 Armario modular con 2 estantes regulables  
 Armoire modulaire avec 2 étagères  
 Modulschrank mit 2 Einlegeböden  
 Armadio modulare con 2 ripiani

□ A301E-G2300  
 ■ A301E-G2335



**A301D**

↑ 200 cm → 50 cm ↗ 59,8 cm

**Double-height modular wardrobe with hanging rod and 2 shelves**  
 Armario modular de doble altura con barra y 2 estantes regulables  
 Armoire modulaire double hauteur avec penderie et 2 étagères  
 Modulschrank mit Kleiderstange und 2 Einlegeböden, doppelte Höhe  
 Armadio modulare doppia altezza con barra appendiabiti e 2 ripiani

□ A301D-G2300  
 ■ A301D-G2335



**2 separate doors | 2 puertas independientes**  
 2 portes séparées | mit 2 Türen | 2 ante indipendenti

**A301R**

↑ 200 cm → 95 cm ↗ 95 cm

**Double-height corner modular wardrobe with 2 shelves**  
 Armario modular rinconera de doble altura con 2 estantes  
 Armoire modulaire d'encoignure avec 2 étagères  
 Modular-Eckschrank mit 2 Einlegeböden, doppelte Höhe  
 Armadio modulare angolare doppia altezza con 2 barre appendiabiti e 2 ripiani

□ A301R-G2300  
 ■ A301R-G2335



**2 separate doors | 2 puertas independientes**  
 2 portes séparées | mit 2 Türen | 2 ante indipendenti

# MODULAR SYSTEM

## A301BB

↑ 100 cm → 100 cm ↻ 59,8 cm

**Double-width modular wardrobe with hanging rod**  
**Armario modular doble ancho con barra para colgar**  
 Armoire modulaire double largeur avec penderie  
 Modulschrank mit Kleiderstange, doppelte Breite  
 Armadio modulare doppia larghezza con barra appendiabiti

▢ A301BB-G2300  
 ▣ A301BB-G2335

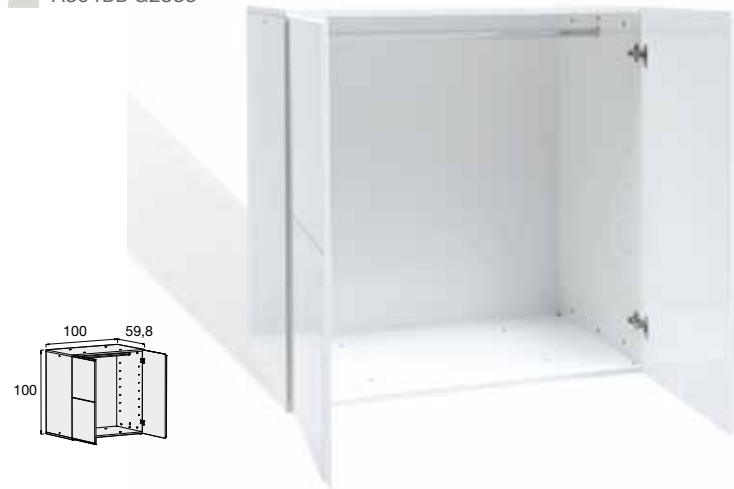

## A301EE

↑ 100 cm → 100 cm ↻ 59,8 cm

**Double-width modular wardrobe with 2 shelves**  
**Armario modular doble ancho con 2 estantes regulables**  
 Armoire modulaire double largeur avec 2 étagères  
 Modulschrank mit 2 Einlegeböden, doppelte Breite  
 Armadio modulare doppia larghezza con 2 ripiani

▢ A301EE-G2300  
 ▣ A301EE-G2335



**A301 modular wardrobe incorporates small adjustable feet, which allow evening the wardrobe when placed on uneven floors. 7mm Min - Max. 11mm.**

Los armarios modulares A301 incorporan un sistema de pequeñas patas regulables en altura que permite nivelar el armario cuando se colocan sobre suelos irregulares (evitando también futuros problemas de humedad).  
 Min. 7mm - Máx. 11mm.

Système de petits pieds réglables inclus dans les armoires modulaires A301. Min. 7mm - Max. 11mm, qui permettent de niveler l'armoire si le sol n'est pas complètement droit.

Der modulare Schrank A301 integriert kleine anpassbare Beine, die eine Nivellierung des Schranks ermöglichen.  
 7 mm min - Max. 11 mm.

Gli armadi modulari includono un sistema di piedini regolabili in altezza che permettono di livellarle quando il pavimento presenta delle irregolarità, aumentando la sua altezza di un minimo di 7 mm (evitando inoltre eventuali accumuli di umidità).  
 Min. 7 mm. - Max. 11 mm.

## A301WD

↑ 50 cm → 100 cm ↻ 59,8 cm

**Double - width upper cabinet module with shelf**  
**Altillo modular doble ancho con estante**  
 Armoire haute modulaire double largeur avec étagère  
 Hochschrank für Modulschrank mit Einlegeboden, doppelte Breite  
 Sopralzo modulare doppia larghezza con ripiano

▢ A301WD-G2300



## A301WR

↑ 50 cm → 95 cm ↻ 95 cm

**Corner upper cabinet module**  
**Altillo modular rinconera**  
 Armoire haute modulaire d'encoignure  
 Hochschrank für Modular-Eckschrank  
 Sopralzo modulare angolare

▢ A301WR-G2300



## A301W

↑ 50 cm → 50 cm ↻ 59,8 cm

**Upper cabinet module (height 50 cm) with shelf**  
**Altillo modular (50 cm altura) con estante**  
 Armoire haute modulaire avec étagère (hauteur 50 cm)  
 Hochschrank für Modulschrank mit Einlegeboden (Höhe 50 cm)  
 Sopralzo modulare con ripiano (altezza 50 cm)

▢ A301W-G2300



## A301WL

↑ 40 cm → 50 cm ↻ 59,8 cm

**Upper cabinet module (height 40 cm) with shelf**  
**Altillo modular (40 cm altura) con estante**  
 Armoire haute modulaire avec étagère (hauteur 40 cm)  
 Hochschrank für Modulschrank mit Einlegeboden (Höhe 40 cm)  
 Sopralzo modulare con ripiano (altezza 40 cm)

▢ A301WL-G2300



# PREMIUM KURVE

## ESSENCE WHITE

MATTE  
FINISH



A317PL-M7700



D217PL-M7700



C137PL-M7700  
70x140 cm



↑ 201,5 cm → 109,8 cm ↻ 60 cm

**A317PL**

▫ A317PL-M7700  
▫ A317PL-M7778



↑ 90 cm → 109,9 cm ↻ 49,5 cm

**D217PL**

▫ D217PL-M7700  
▫ D217PL-M7778



↑ 87,1 cm → 146 cm ↻ 80 cm

**C137PL**

▫ C137PL-M7700  
▫ C137PL-M7778



↑ 76,6 cm → 146 cm ↻ 80 cm



↑ 74,6 cm → 146 cm ↻ 80 cm

**Cot 70x140 | Cuna 70x140 | Lit bébé 70x140**  
*Babybett 70x140 | Lettino 70x140*

**Toddler bed | Cama infantil | Lit cadet**  
*Kinderbett | Letto*

**Desk | Escritorio | Bureau**  
*Schreibtisch | Scrivania*

# PREMIUM KURVE

## ESSENCE NATURE

MATTE  
FINISH



C137P-M7791  
70x140 cm

A317P-M7791

D217P-M7791



↑ 201,5 cm → 109,8 cm ↻ 60 cm

A317P

■ A317P-M7791



↑ 90 cm → 109,9 cm ↻ 49,5 cm

D217P

■ D217P-M7791



↑ 87,1 cm → 146 cm ↻ 80 cm

C137P

■ C137P-M7791



↑ 76,6 cm → 146 cm ↻ 80 cm



↑ 74,6 cm → 146 cm ↻ 80 cm

Cot 70x140 | Cuna 70x140 | Lit bébé 70x140  
Babybett 70x140 | Lettino 70x140

Toddler bed | Cama infantil | Lit cadet  
Kinderbett | Letto

Desk | Escritorio | Bureau  
Schreibtisch | Scrivania

# PREMIUM KURVE

## ESSENCE COCO

MATTE  
FINISH



C137P-M7792  
70x140cm



A317P-M7792



D217P-M7792



↑ 201,5 cm → 109,8 cm ↻ 60 cm

**A317P**

■ A317P-M7792



↑ 90 cm → 109,9 cm ↻ 49,5 cm

**D217P**

■ D217P-M7792



↑ 87,1 cm → 146 cm ↻ 80 cm

**C137P**

■ C137P-M7792



↑ 76,6 cm → 146 cm ↻ 80 cm



↑ 74,6 cm → 146 cm ↻ 80 cm



# PREMIUM KURVE

## WHITE

MATTE  
FINISH



A317-M7700

D217-M7700

C137-M7700  
70 x 140 cm



↑ 199,5 cm → 109,8 cm ↻ 60 cm

**A317**

□ A317-M7700



↑ 84 cm → 109,9 cm ↻ 49,5 cm

**D217**

□ D217-M7700



↑ 86,4 cm → 146 cm ↻ 80 cm

**C137**

□ C137-M7700



↑ 75,9 cm → 146 cm ↻ 80 cm

**Toddler bed | Cama infantil | Lit cadet  
Kinderbett | Letto**



↑ 74,6 cm → 146 cm ↻ 80 cm

**Desk | Escritorio | Bureau  
Schreibtisch | Scrivania**

# PREMIUM KURVE

## GREY

MATTE  
FINISH



A317-M7778

D217-M7778

C137-M7778  
70x140 cm



↑ 199,5 cm → 109,8 cm ↻ 60 cm

**A317**  
A317-M7778



↑ 84 cm → 109,9 cm ↻ 49,5 cm

**D217**  
D217-M7778



↑ 86,4 cm → 146 cm ↻ 80 cm

**C137**  
C137-M7778



↑ 75,9 cm → 146 cm ↻ 80 cm

**Toddler bed** | Cama infantil | Lit cadet  
Kinderbett | Letto



↑ 74,6 cm → 146 cm ↻ 80 cm

**Desk** | Escritorio | Bureau  
Schreibtisch | Scrivania

# COTS & BATH CHANGERS

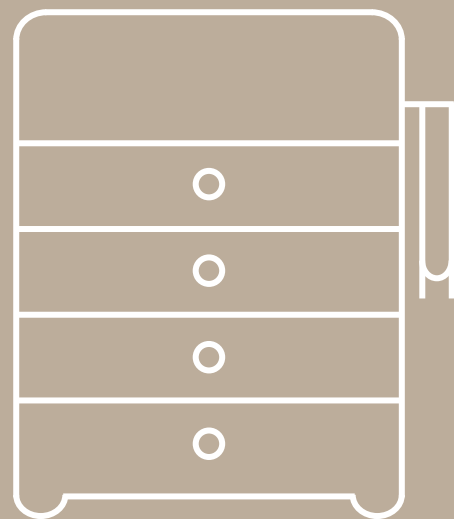

**COTS & BATH CHANGERS** | CUNAS Y BAÑERAS | LITS BÉBÉ ET BAIGNOIRES  
*BABYBETTEN UND WASCHTISCHE* | LETTINI E BAGNETTI



JOY WHITE



JOY GREY



JOY MARE



JOY ROSE

B759



93 x 79 x 49 cm

C150



80 x 132 x 64 cm



Close-up of hidden wheel  
Detalle de la rueda oculta de la cuna  
Détail de la roue cachée du lit bébé  
Detailansicht des versteckten Rades  
Particolare della ruota nascosta del lettino

MATTE  
FINISH



C150-M7779  
60x 120 cm



633-179

B759-M7779

## JOY ETNIK



BUBBLE WHITE



BUBBLE CIELO



BUBBLE GREY



BUBBLE ARENA



B754



93 x 79 x 49 cm

C181



91 x 126,1 x 72,9 cm

\* +info pages 10-21

5 stages with additional kits or accessories

5 etapas con packs o accesorios adicionales

5 étapes avec des kits ou accessoires supplémentaires

5 Etappen mit zusätzlichen Kits und Zubehör

5 fasi con packs o accessori opzionali



# BUBBLE



C181-M7752 + WJB180-M77  
(pages 18-19)



633-112

B754-M7752

## BUBBLE CORAL



# BUBBLE



633-055

B754-M7755



C181-M7755  
60x120 cm

## BUBBLE MINT



# JUNIOR FURNITURE



**JUNIOR FURNITURE | MOBILIARIO JUVENIL | MOBILIER BÉBÉ**  
*BABYMÖBEL | MOBILI PER BAMBINI*

# JUNIOR BEDS

SIZE  
90x200  
cm

JUNIOR BEDS | CAMAS JUVENILES  
LITS JUNIOR | JUGENDBETTEN | LETTI JUNIOR



**Slatted bed base**  
Somier de lamas  
Sommier à lattes  
Lattenrost  
Rete a doghe

**QC417**

Drawers | Cajones inferiores  
Tiroirs | Schubladen | Cassettoni

Trundle bed | Cama nido  
Lit gigogne | Ausziehbett | Letto estraibile

QC417C-M7700

QC417N-M7700

MATTE  
FINISH

↑ 101,7 cm → 214,1 cm ↻ 101,8 cm

PREMIUM KURVE



**QC501**

Drawers | Cajones inferiores  
Tiroirs | Schubladen | Cassettoni

Trundle bed | Cama nido  
Lit gigogne | Ausziehbett | Letto estraibile

QC501C-G2300

QC501N-G2300

GLOSS  
FINISH

↑ 101,7 cm → 208,1 cm ↻ 101,8 cm

MODULAR



**QC536**

Drawers | Cajones inferiores  
Tiroirs | Schubladen | Cassettoni

Trundle bed | Cama nido  
Lit gigogne | Ausziehbett | Letto estraibile

QC536C-M7700

QC536N-M7700

QC536C-M7751

QC536N-M7751

QC536C-M7752

QC536N-M7752

QC536C-M7753

QC536N-M7753

QC536C-M7778

QC536N-M7778

QC536C-M7781

QC536N-M7781

MATTE  
FINISH

↑ 95,5 cm → 206 cm ↻ 102 cm

EVEN



**QC559**

Drawers | Cajones inferiores  
Tiroirs | Schubladen | Cassettoni

Trundle bed | Cama nido  
Lit gigogne | Ausziehbett | Letto estraibile

QC559C-M7700

QC559N-M7700

QC559C-M7778

QC559N-M7778

QC559C-M7779

QC559N-M7779

QC559C-M7781

QC559N-M7781

QC559C-M7782

QC559N-M7782

MATTE  
FINISH

↑ 95,5 cm → 206 cm ↻ 102 cm

JOY



**QC554**

Drawers | Cajones inferiores  
Tiroirs | Schubladen | Cassettoni

Trundle bed | Cama nido  
Lit gigogne | Ausziehbett | Letto estraibile

QC554C-M7700

QC554N-M7700

MATTE  
FINISH

↑ 95,5 cm → 206 cm ↻ 102 cm

BUBBLE



**Slatted bed base**  
Somier de lamas  
Sommier à lattes  
Lattenrost  
Rete a doghe

**QC601**

Drawers | Cajones inferiores  
Tiroirs | Schubladen | Cassettoni

Trundle bed | Cama nido  
Lit gigogne | Ausziehbett | Letto estraibile

QC601C-G2300

QC601N-G2300

GLOSS  
FINISH

↑ 101,7 cm → 208,1 cm ↻ 101,8 cm





MODULAR PLUS

# BEDSIDE TABLE



QM417

↑ 63,4 cm → 61,8 cm ↻ 40 cm

-  QM417-M7700
-  QM417-M7778
-  QM417-M7791
-  QM417-M7792





PREMIUM KURVE



QM501

↑ 58,5 cm → 61,8 cm ↻ 40 cm

-  QM501-G2300
-  QM501-G2335





MODULAR



QM506

↑ 58,5 cm → 61,8 cm ↻ 40 cm

- |   |   |
|---|---|
|  QM506-G2300   |  QM506-G2353   |
|  QM506-G2335   |  QM506-G2379   |
|  QM506-G2351  |  QM506-G2381  |
|  QM506-G2352 |  QM506-G2392 |



CLIP



QM536

↑ 60,7 cm → 60 cm ↻ 45,9 cm

-  QM536-M7700
-  QM536-M7751
-  QM536-M7752
-  QM536-M7753
-  QM536-M7778
-  QM536-M7781





EVEN



QM554

↑ 60,7 cm → 60 cm ↻ 46,2 cm

-  QM554-M7700
-  QM554-M7751
-  QM554-M7752
-  QM554-M7753
-  QM554-M7755
-  QM554-M7778





BUBBLE



QM559

↑ 60,7 cm → 60 cm ↻ 46,2 cm

-  QM559-M7700
-  QM559-M7778
-  QM559-M7779
-  QM559-M7781
-  QM559-M7782



JOY



**Hidden zipper pocket for cell phone**  
**Bolsillo con cremallera para el móvil**  
Poche zipée pour téléphone portable  
*Äusseres Reissverschlussfach für Handy*  
Tasca con cerniera zip per il telefonino



**Fastening system for stroller**  
**Sistema de sujeción al carro de paseo**  
Système d'accroche poussette  
*Kinderwagenbefestigung*  
Sistema di aggancio al passeggino



**Zipper closure**  
**Cierre con cremallera**  
Fermeture éclair  
*Reissverschluss*  
Chiusura con cerniera zip

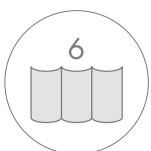

**Number of compartments**  
**Número de compartimentos**  
Nombre de compartiments  
*Anzahl der inneren Staufächer*  
Numero di scompartimenti interni

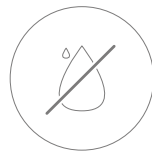

**Waterproof lining**  
**Forro interior impermeable**  
Doublure intérieure imperméable  
*Inneres Futter wasserdicht*  
Fodera interna impermeabile



**Leatherette**  
**Polipiel**  
Simili-cuir  
*Kunstleder*  
Ecopelle



**Velcro closure**  
**Cierre con velcro**  
Fermeture en scratch  
*Klettverschluss*  
Chiusura velcro

# URBAN BAGS



**NURSING BAGS | BOLSOS DE MATERNIDAD | SACS À LANGER**  
*WICKELTASCHEN | BORSE MAMMA*

# UP&DOWN BLU

BAGS | BOLSOS | SACS | TASCHEN | BORSE

1100-751

33 x 41 x 13 cm

**Tote diaper bag**  
**Bolso panera**

Sac à langer  
*Wickeltasche Tote-Bag*  
Borsa passeggio



1400-751

9 x 9 x 9 cm

**Pacifier holder**  
**Portachupete**

Porte sucette  
*Schnullertasche*  
Portaciuccio



1702-751

21 x 24 x 3 cm (closed)  
58 x 44 x 3 cm (open)

**Changing mat**  
**Cambiador Bebé**  
Matelas à langer  
*Reise-Wickelunterlage*  
Fasciatoio da viaggio



1202-751

32 x 42 x 12 cm

**Carry all diaper bag**  
**Bolso maternidad**

Sac à langer en bandoulière  
*Wickeltasche Schultertasche*  
Borsa mamma



1500-751

22 x 9 x 9 cm

**Bottle holder**  
**Portabiberón**

Porte biberon  
*Fläschchentasche*  
Portabiberon



1900-751

19 x 30 x 8 cm

**Toiletry bag**  
**Neceser**

Trousse de toilette  
*Kulturbeutel*  
Trousse toilette



1300-751

35 x 31 x 14 cm

**Backpack diaper bag**  
**Mochila maternal**

Sac à dos à langer  
*Wickeltasche Rucksack*  
Zainetto mamma



1601-751

26 x 18 x 2 cm (closed)  
26 x 36 x 2 cm (open)

**Document holder**  
**Portadocumentos**

Porte-documents  
*Dokumententasche*  
Portadocumenti



**Waterproof lining | Forro interior impermeable**

doublure intérieure imperméable | *Inneres Futter wasserdicht*  
Fodera interna impermeabile



**Leatherette | Polipiel**  
Simili-cuir | *Kunstleder*  
Ecopelle



# ONDA WHITE

BAGS | BOLSOS | SACS | TASCHEN | BORSE

1100-777

33 x 41 x 13 cm

**Tote diaper bag**  
**Bolso panera**  
 Sac à langer  
*Wickeltasche Tote-Bag*  
 Borsa passeggio



1400-777

9 x 9 x 9 cm

**Pacifier holder**  
**Portachupete**  
 Porte sucette  
*Schnullertasche*  
 Portaciuccio



1702-777

21 x 24 x 3 cm (closed)  
 58 x 44 x 3 cm (open)

**Changing mat**  
**Cambiador Bebé**  
 Matelas à langer  
*Reise-Wickelunterlage*  
 Fasciatoio da viaggio



1202-777

32 x 42 x 12 cm

**Carry all diaper bag**  
**Bolso maternidad**  
 Sac à langer en bandoulière  
*Wickeltasche Schultertasche*  
 Borsa mamma



1500-777

22 x 9 x 9 cm

**Bottle holder**  
**Portabiberón**  
 Porte biberon  
*Fläschchentasche*  
 Portabiberon



1900-777

19 x 30 x 8 cm

**Toiletry bag**  
**Necesar**  
 Trousse de toilette  
*Kulturbeutel*  
 Trousse toilette



1300-777

35 x 31 x 14 cm

**Backpack diaper bag**  
**Mochila maternal**  
 Sac à dos à langer  
*Wickeltasche Rucksack*  
 Zainetto mamma



1601-777

26 x 18 x 2 cm (closed)  
 26 x 36 x 2 cm (open)

**Document holder**  
**Portadocumentos**  
 Porte-documents  
*Dokumententasche*  
 Portadocumenti



**Waterproof lining | Forro interior impermeable**  
 Doublure intérieure imperméable | *Inneres Futter wasserdicht*  
 Fodera interna impermeabile



**Leatherette | Polipiel**  
 Simili-cuir | *Kunstleder*  
 Ecopelle



# FIORE WHITE

BAGS | BOLSOS | SACS | TASCHEN | BORSE

1100-790

33 x 41 x 13 cm

**Tote diaper bag**

**Bolso panera**

Sac à langer

*Wickeltasche Tote-Bag*

Borsa passeggio

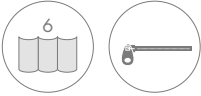

1400-790

9 x 9 x 9 cm

**Pacifier holder**

**Portachupete**

Porte sucette

*Schnullertasche*

Portaciuccio



1702-790

21 x 24 x 3 cm (closed)  
58 x 44 x 3 cm (open)

**Changing mat**

**Cambiador Bebé**

Matelas à langer

*Reise-Wickelunterlage*

Fasciatoio da viaggio



1202-790

32 x 42 x 12 cm

**Carry all diaper bag**

**Bolso maternidad**

Sac à langer en bandoulière

*Wickeltasche Schultertasche*

Borsa mamma

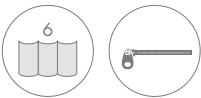

1500-790

22 x 9 x 9 cm

**Bottle holder**

**Portabiberón**

Porte biberon

*Fläschchentasche*

Portabiberon



1900-790

19 x 30 x 8 cm

**Toiletry bag**

**Necesar**

Trousse de toilette

*Kulturbeutel*

Trousse toilette



1300-790

35 x 31 x 14 cm

**Backpack diaper bag**

**Mochila maternal**

Sac à dos à langer

*Wickeltasche Rucksack*

Zainetto mamma



1601-790

26 x 18 x 2 cm (closed)  
26 x 36 x 2 cm (open)

**Document holder**

**Portadocumentos**

Porte-documents

*Dokumententasche*

Portadocumenti



**Waterproof lining | Forro interior impermeable**

Doublure intérieure imperméable | *Innere Futter wasserdicht*

Fodera interna impermeabile



**Leatherette | Polipiel**

Simili-cuir | *Kunstleder*

Ecopelle





# UP&DOWN ROSA

BAGS | BOLSOS | SACS | TASCHEN | BORSE

1100-752

33 x 41 x 13 cm

**Tote diaper bag**  
**Bolso panera**  
 Sac à langer  
*Wickeltasche Tote-Bag*  
 Borsa passeggio



1400-752

9 x 9 x 9 cm

**Pacifier holder**  
**Portachupete**  
 Porte sucette  
*Schnullertasche*  
 Portaciuccio



1702-752

21 x 24 x 3 cm (closed)  
 58 x 44 x 3 cm (open)

**Changing mat**  
**Cambiador Bebé**  
 Matelas à langer  
*Reise-Wickelunterlage*  
 Fasciatoio da viaggio



1202-752

32 x 42 x 12 cm

**Carry all diaper bag**  
**Bolso maternidad**  
 Sac à langer en bandoulière  
*Wickeltasche Schultertasche*  
 Borsa mamma



1500-752

22 x 9 x 9 cm

**Bottle holder**  
**Portabiberón**  
 Porte biberon  
*Fläschchentasche*  
 Portabiberon



1900-752

19 x 30 x 8 cm

**Toiletry bag**  
**Necesar**  
 Trousse de toilette  
*Kulturbeutel*  
 Trousse toilette



1300-752

35 x 31 x 14 cm

**Backpack diaper bag**  
**Mochila maternal**  
 Sac à dos à langer  
*Wickeltasche Rucksack*  
 Zainetto mamma



1601-752

26 x 18 x 2 cm (closed)  
 26 x 36 x 2 cm (open)

**Document holder**  
**Portadocumentos**  
 Porte-documents  
*Dokumententasche*  
 Portadocumenti



**Waterproof lining | Forro interior impermeable**  
 Doublure intérieure imperméable | *Inneres Futter wasserdicht*  
 Fodera interna impermeabile



**Leatherette | Polipiel**  
 Simili-cuir | *Kunstleder*  
 Ecopelle



# BAROCCO

BAGS | BOLSOS | SACS | TASCHEN | BORSE

1100-710

33 x 41 x 13 cm

**Tote diaper bag**  
**Bolso panera**  
 Sac à langer  
*Wickeltasche Tote-Bag*  
 Borsa passeggio



1500-710

22 x 9 x 9 cm

**Bottle holder**  
**Portabiberón**  
 Porte biberon  
*Fläschchentasche*  
 Portabiberon



1700-710

21 x 24 x 3 cm (closed)  
 75 x 44 x 3 cm (open)

**Changing mat**  
**Cambiador Bebé**  
 Matelas à langer  
*Reise-Wickelunterlage*  
 Fasciatoio da viaggio



1200-710

26 x 42 x 15 cm

**Carry all diaper bag**  
**Bolso maternidad**  
 Sac à langer en bandoulière  
*Wickeltasche Schultertasche*  
 Borsa mamma



1600-710

19 x 26 x 2 cm

**Document holder**  
**Portadocumentos**  
 Porte-documents  
*Dokumententasche*  
 Portadocumenti



1900-710

19 x 30 x 8 cm

**Toiletry bag**  
**Neceser**  
 Trousse de toilette  
*Kulturbeutel*  
 Trousse toilette



1300-710

35 x 31 x 14 cm

**Backpack diaper bag**  
**Mochila maternal**  
 Sac à dos à langer  
*Wickeltasche Rucksack*  
 Zainetto mamma

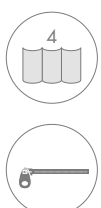

**Leatherette**  
**Polipiel**  
 Simili-cuir  
*Kunstleder*  
 Ecopelle



**Waterproof lining**  
**Forro interior impermeable**  
 Doublure intérieure imperméable  
*Inneres Futter wasserdicht*  
 Fodera interna impermeabile

# ONDA GREY

BAGS | BOLSOS | SACS | TASCHEN | BORSE

1100-778

33 x 41 x 13 cm

**Tote diaper bag**  
**Bolso panera**  
 Sac à langer  
 Wickeltasche Tote-Bag  
 Borsa passeggio



1400-778

9 x 9 x 9 cm

**Pacifier holder**  
**Portachupete**  
 Porte sucette  
 Schnullertasche  
 Portaciuccio



1702-778

21 x 24 x 3 cm (closed)  
 58 x 44 x 3 cm (open)

**Changing mat**  
**Cambiador Bebé**  
 Matelas à langer  
 Reise-Wickelunterlage  
 Fasciatoio da viaggio



1202-778

32 x 42 x 12 cm

**Carry all diaper bag**  
**Bolso maternidad**  
 Sac à langer en bandoulière  
 Wickeltasche Schultertasche  
 Borsa mamma



1500-778

22 x 9 x 9 cm

**Bottle holder**  
**Portabiberón**  
 Porte biberon  
 Fläschchentasche  
 Portabiberon



1900-778

19 x 30 x 8 cm

**Toiletry bag**  
**Necesar**  
 Trousse de toilette  
 Kulturbeutel  
 Trousse toilette



1300-778

35 x 31 x 14 cm

**Backpack diaper bag**  
**Mochila maternal**  
 Sac à dos à langer  
 Wickeltasche Rucksack  
 Zainetto mamma



1601-778

26 x 18 x 2 cm (closed)  
 26 x 36 x 2 cm (open)

**Document holder**  
**Portadocumentos**  
 Porte-documents  
 Dokumententasche  
 Portadocumenti



**Waterproof lining | Forro interior impermeable**  
 Doublure intérieure imperméable | Inneres Futter wasserdicht  
 Fodera interna impermeabile



**Leatherette | Polipiel**  
 Simili-cuir | Kunstleder  
 Ecopelle

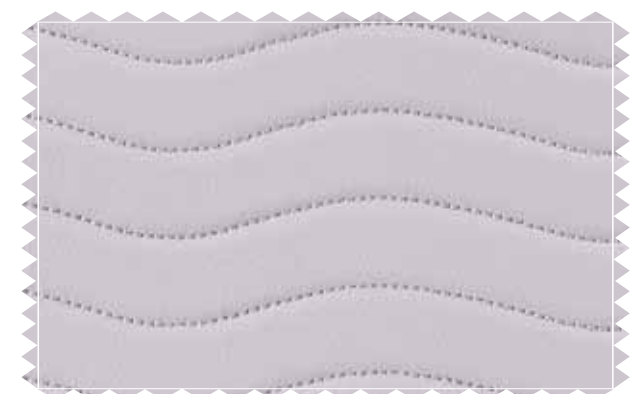

# ONDA ARENA

BAGS | BOLSOS | SACS | TASCHEN | BORSE

1100-753

33 x 41 x 13 cm

**Tote diaper bag**

**Bolso panera**

Sac à langer

*Wickeltasche Tote-Bag*

Borsa passeggio

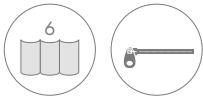

1400-753

9 x 9 x 9 cm

**Pacifier holder**

**Portachupete**

Porte sucette

*Schnullertasche*

Portaciuccio



1702-753

21 x 24 x 3 cm (closed)  
58 x 44 x 3 cm (open)

**Changing mat**

**Cambiador Bebé**

Matelas à langer

*Reise-Wickelunterlage*

Fasciatoio da viaggio



1202-753

32 x 42 x 12 cm

**Carry all diaper bag**

**Bolso maternidad**

Sac à langer en bandoulière

*Wickeltasche Schultertasche*

Borsa mamma

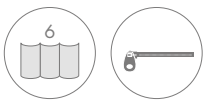

1500-753

22 x 9 x 9 cm

**Bottle holder**

**Portabiberón**

Porte biberon

*Fläschchentasche*

Portabiberon



1900-753

19 x 30 x 8 cm

**Toiletry bag**

**Necesar**

Trousse de toilette

*Kulturbeutel*

Trousse toilette

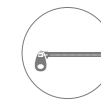

1300-753

35 x 31 x 14 cm

**Backpack diaper bag**

**Mochila maternal**

Sac à dos à langer

*Wickeltasche Rucksack*

Zainetto mamma



1601-753

26 x 18 x 2 cm (closed)  
26 x 36 x 2 cm (open)

**Document holder**

**Portadocumentos**

Porte-documents

*Dokumententasche*

Portadocumenti



**Waterproof lining | Forro interior impermeable**

Doublure intérieure imperméable | *Inneres Futter wasserdicht*

Fodera interna impermeabile



**Leatherette | Polipiel**

Simili-cuir | *Kunstleder*

Ecopelle



TOYS



**TOYS** | JUGUETES | JOUETS | SPIELZEUGE | GIOCATTOLI

# RIDER

U31CBR-7700



WOODEN HORSES WITH WHEELS | CABALLITOS DE MADERA CON RUEDAS  
CHEVAUX DE BOIS À ROULETTES | HOLZPFERDE AUF ROLLEN | CAVALLI DI LEGNO CON RUOTE

U31CBR-7751



U31CBR-7752



U31CBR-7753



U31CBR-7755



U31CBR-7778



MEASURES | MEDIDAS  
MESURES | MAßE | MISURE



**ROCKING HORSES | CABALLITOS BALANCÍN**  
CHEVAUX À BASCULE | SCHAUKELPFERDE | CAVALLI A DONDOLO

U32CBB-7700



U32CBB-7751



U32CBB-7752



U32CBB-7753



U32CBB-7755



U32CBB-7778



**MEASURES | MEDIDAS**  
MESURES | MAßE | MISURE

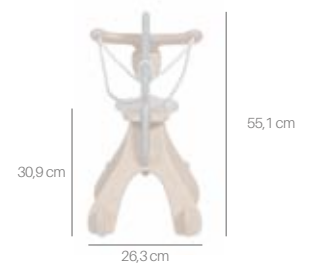

# WIND

WOODEN PLANES | AVIONES DE MADERA  
AVIONS EN BOIS | HOLZFLUGZEUGE | AEREI DI LEGNO

U34AVI-7700



U34AVI-7751



U34AVI-7753



U34AVI-7755



U34AVI-7778



MEASURES | MEDIDAS  
MESURES | MAßE | MISURE

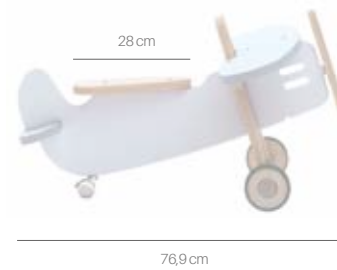



**DESK & CHAIR | ESCRITORIO Y SILLA**  
BUREAU ET CHAISE | SCHREIBTISCH UND STUHL | CASETTA/SCRIVANIA E SGABELLO

U33MES-7700



U33MES-7751



U33MES-7752



U33MES-7753



U33MES-7755



U33MES-7778



**MEASURES | MEDIDAS**  
MESURES | MAßE | MISURE

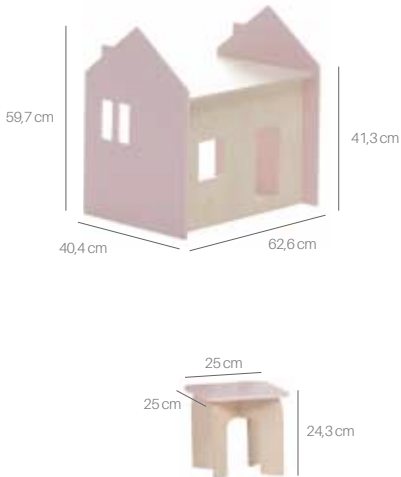

# PRINCESS

DOLL'S PRAM | CARRITO BEBÉ  
POUSSETTE POUR POUPEE | PUPPENWAGEN | PASSEGGINO PER BAMBOLE

U36CRT-7700



U36CRT-7752



# PRIX

WOODEN MOTORBIKE | MOTO DE MADERA INFANTIL  
MOTO EN BOIS | HOLZMOTORRAD | MOTO GIOCATTOLO DI LEGNO

U35MOT-7700



## MEASURES | MEDIDAS MESURES | MAßE | MISURE

Doll's pram | Carrito de bebé | Poussette pour poupée  
Puppenwagen | Passeggino per bambole



Motorbike | Moto | Moto en bois  
Holzmotorrad | Moto giocattolo di legno





# STELLA

LAMPS | LÁMPARAS | LAMPES | LAMPEN | LAMPADE

Pendant light | Lámpara de techo | Suspension | Hängelampe | Lampadario

20 x 40 x 40 cm



L597T-0153



L597T-0178



L597T-7900



L597T-8100



L597T-8200

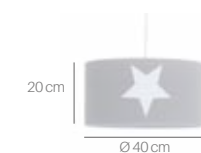

Table lamp | Lámpara de sobremesa | Lampe de chevet | Nachttischlampe | Lampada da tavolo

33,5 x 20 x 20 cm



LS597M-0153



LS597M-0178



LS597M-7900



LS597M-8100



LS597M-8200

Max.  
240 V

12V



Child safe

L597M-0153

L597M-0178

L597M-7900

L597M-8100

L597M-8200

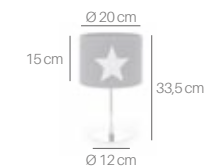

Floor lamp | Lámpara de pie | Lampadaire | Stehlampe | Lampada piantana

146 x 40 x 40 cm



L597S-0153



L597S-0178



L597S-7900



L597S-8100



L597S-8200

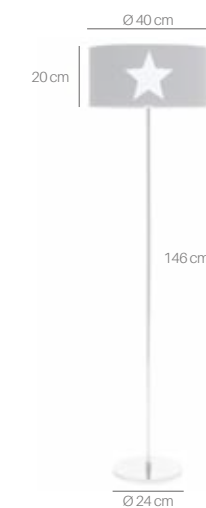

## LAMPS | LÁMPARAS | LAMPES | LAMPEN | LAMPADE

### Ceiling lamp | Lámpara de techo | Suspension | Deckenlampe | Lampadario

15 x 40 x 40 cm



### Wall lamp | Lámpara de pared | Applique murale | Wandlampe | Lampada applique

40 x 40 x 15 cm

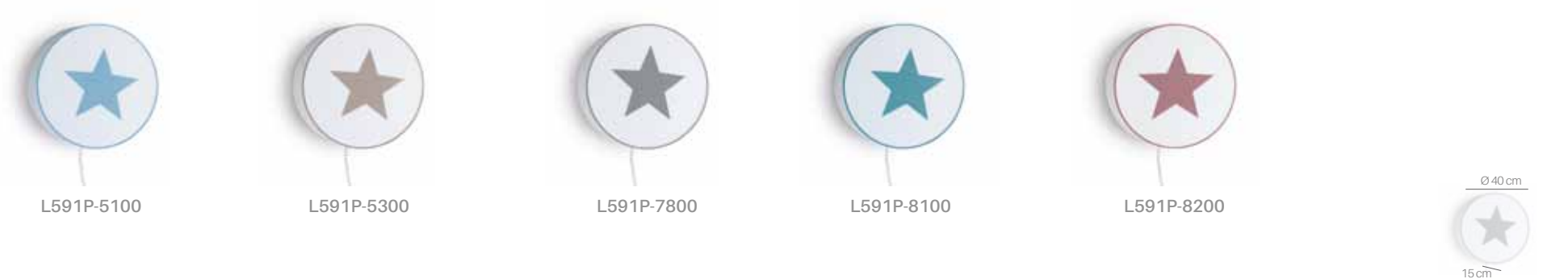

### Table lamp | Lámpara de sobremesa | Lampe de chevet | Nachttischlampe | Lampada da tavolo

35 x 14 x 14 cm



### Floor lamp | Lámpara de pie | Lampadaire | Stehlampe | Lampada da terra

141,5 x 20 x 20 cm



# SHINE

**Pendant light | Lámpara de techo**  
Suspension | *Hängelampe* | Lampadario

20 x 40 x 40 cm



L539-1400



L539-2300

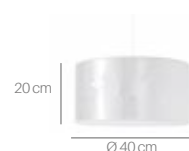

# DREAMS

**Pendant light | Lámpara de techo**  
Suspension | *Hängelampe* | Lampadario

34 x 30 x 12 cm ☆ 37 x 39 x 12 cm



L534-2070



L534-3070



# VOLARE

**Wall lamp | Lámpara de pared**  
Applique murale | *Wandlampe* | Lampada applique

28 x 28 x 13 cm



L599P-7700



**Table lamp | Lámpara de sobremesa**  
Lampe de chevet | *Nachttischlampe* | Lampada da tavolo

35 x 20 x 20 cm



LS537-1400



LS537-2300

Max. 240 V

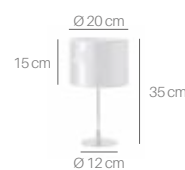

L537-1400

L537-2300

**Table lamp | Lámpara de sobremesa**  
Lampe de chevet | *Nachttischlampe* | Lampada da tavolo

40 x 18 x 12 cm ☆ 35 x 24 x 12 cm



LS532-2070



LS532-3070

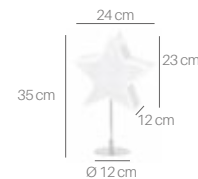
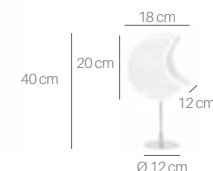

L532-2070

L532-3070

**Table lamp | Lámpara de sobremesa**  
Lampe de chevet | *Nachttischlampe* | Lampada da tavolo

42 x 29 x 12 cm



L599M-7700

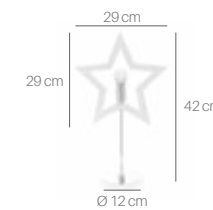

**Floor lamp | Lámpara de pie | Lampadaire | Stehlampe | Lampada piantana**

150 x 40 x 40 cm



L538-1400



L538-2300

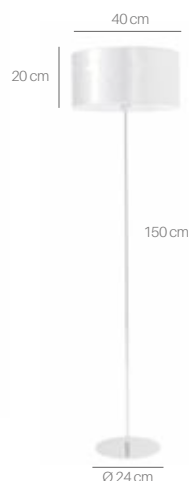

**Floor lamp | Lámpara de pie | Lampadaire | Stehlampe | Lampada piantana**

164 x 30 x 12 cm ☆ 156 x 39 x 12 cm



L533-2070



L533-3070

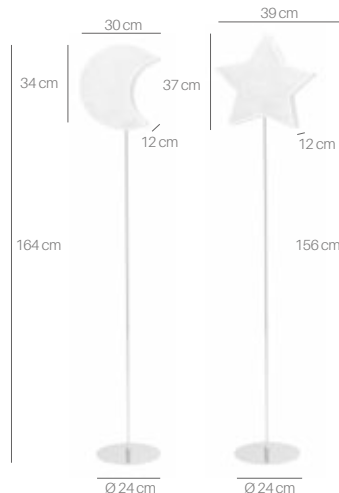

**Pendant light | Lámpara de techo**  
Suspension | *Hängelampe* | Lampadario

52 x 52 cm



L599T-7700



**MDF star | Estrella en MDF**  
Étoile en MDF | Stern aus MDF | Stella in MDF

## ACCESSORIES | ACCESORIOS | ACCESSOIRES | ZUBEHÖR | ACCESSORI

**H560 Modular shelf (small) | Balda-estante modular (pequeña)**  
Étagère murale modulaire (petite) | Wandregal Modular (klein) | Mensola modulare (piccola)

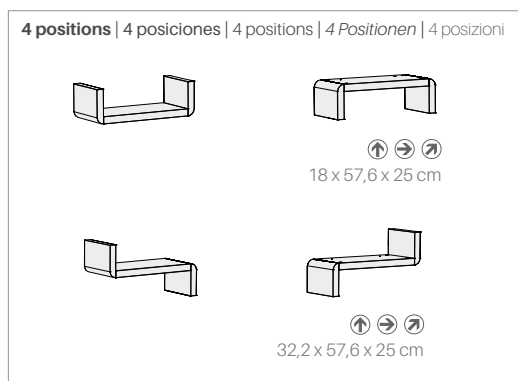

**H561 Modular shelf (large) | Balda-estante modular (grande)**  
Étagère murale modulaire (grande) | Wandregal Modular (groß) | Mensola modulare (grande)

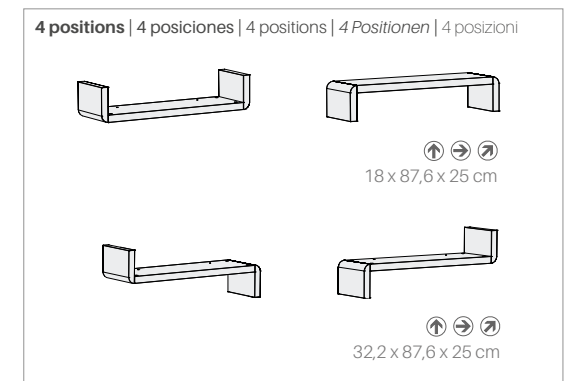

**F Letters | Letras | Lettres | Buchstaben | Lettere**

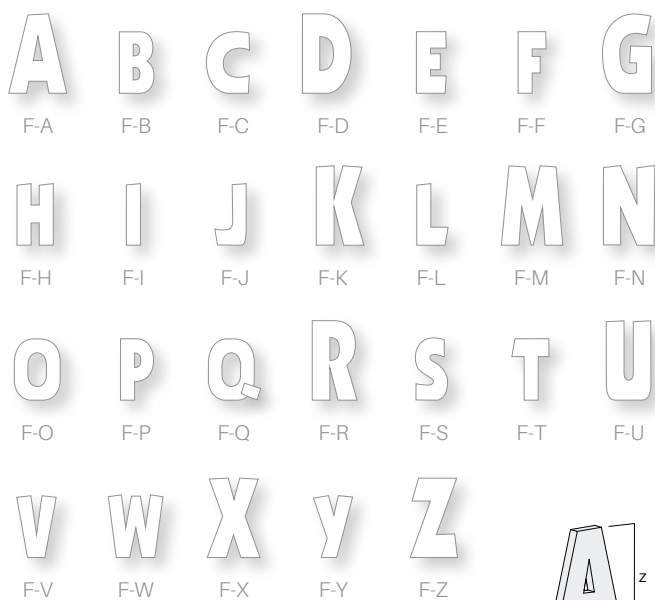

REF.	Y (cm)	Z (cm)
F-A	12,8	17,6
F-B	7,7	13,6
F-C	9,6	13,6
F-D	10,8	17,6
F-E	6,6	13,6
F-F	6,2	13,6
F-G	10,8	17,6
F-H	8	13,6
F-I	3,1	13,6
F-J	7	13,6
F-K	10,6	17,6
F-L	6,9	13,6
F-M	13,5	17,6
F-N	11,3	17,6
F-O	10,2	13,6
F-P	7,2	13,6
F-Q	11,6	13,6
F-R	10	17,6
F-S	7,1	13,6
F-T	8,2	13,6
F-U	9,8	17,6
F-V	8,9	13,9
F-W	12	13,9
F-X	11,7	17,6
F-Y	8,7	13,6
F-Z	10,5	17,6

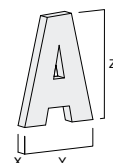

Composition: Padded vinyl | Composición: Vinilo espumado | Composition: Vinile en mousse  
Zusammensetzung: Aufgeschämte Vinyl | Composizione: Schiuma di vinile

**H555 Box shelves | Box-pared | Cube mural | Wandwürfel | Armadietto**

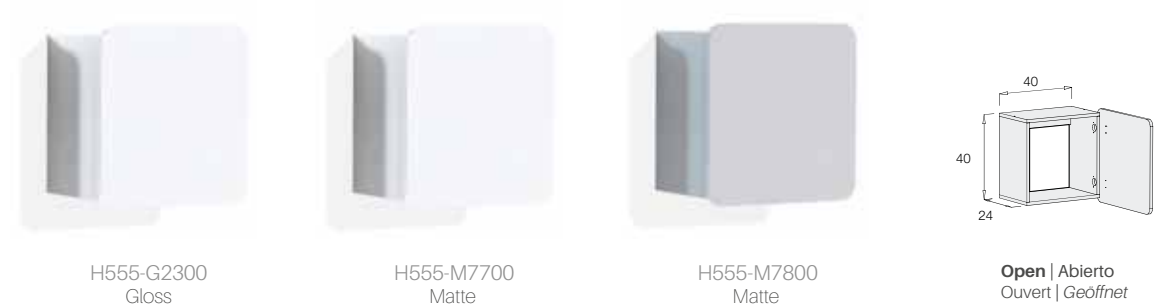

**R-VE1 Bath changer | Vestidor bañera | Matelas à langer baignoire | Wickelauflage | Fasciatoio bagnetto**

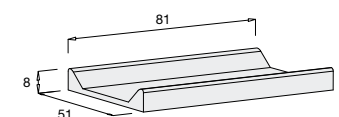

# ORGANIC SOJA

MATTRESSES | COLCHONES | MATELAS | MATRATZE | MATERASSI

## Organic mattress for babies made with soybean oil.

Organic cotton fabric. Certified "Organic Cotton", which attests that the mattress on which the baby lies has been manufactured with cotton grown under organic farming methods, free of pesticides and other harmful substances.

Prevents SIDS. Mattress designed based on recommendations to prevent SIDS.

Bio core. Made from natural soybean oil, more respectful towards the environment.

Breathable to ensure maximum hygiene. Its ventilation channels keep the baby fresh and dry. Easy to clean. Its all-around zipper allows the cover to be removed and washed easily without losing its properties.

## Colchón orgánico para bebés elaborado con aceites naturales de soja.

Tejido de algodón orgánico. Certificado "Organic Cotton" que garantiza que el tejido con el que está fabricado el colchón es natural, procedente de cultivo de algodón ecológico, libre de pesticidas y sustancias nocivas para la salud del bebé.

Prevención muerte súbita. Colchón especialmente diseñado para prevenir la muerte súbita del lactante, siguiendo todas las recomendaciones de los expertos.

Núcleo Bio. Fabricado con aceites naturales de soja. Por su composición natural es más respetuoso con el medio ambiente y garantiza una mayor suavidad para el descanso.

Transpirable e higiénico. Los canales de aireación en ambos lados del colchón ofrecen la máxima transpiración y frescura para el descanso del bebé. Desenfundable y de fácil lavado gracias a la cremallera perimetral que incorpora para poder separar cada una de las piezas.

## Matelas organique pour bébé fabriqué à partir d'huile de soja naturelle.

Tissu en coton BIO. Certification "Coton Biologique" garantissant que le matelas sur lequel bébé dormira est produit en coton issu de l'agriculture biologique, sans l'utilisation de pesticides ou d'autres substances pernicieuses.

Prévention morte subite du nourrisson. Matelas conçu en suivant les recommandations pour réduire le risque du syndrome de mort subite du nourrisson.

Noyau Bio. Fabriqué à partir d'huile de soja naturelle, plus respectueux de l'environnement.

Transpirable pour une hygiène parfaite. Système de ventilation pour que bébé soit toujours frais et sec. Facile à nettoyer. Sa fermeture éclair tout autour permet de laver la housse séparément tout en conservant ses propriétés.



**Rolled up for easier transport**  
Enrollado para facilitar el transporte  
Enroulé pour un transport facile  
Gerollt für einfachen Transport  
Arrotolato per facilitarne il trasporto



## Organische Matratze für Babys, hergestellt mit Sojaöl.

Stoff aus Bio-Baumwolle. Das Gütesiegel "kbA" garantiert, dass der Stoff aus kontrolliert ökologischem Anbau stammt und frei von jeglichen Pestiziden und Schadstoffen ist.

Vorbeugung des plötzlichen Kindstodes. Matratze entworfen entsprechend Empfehlungen zur Vorbeugung des plötzlichen Kindstodes.

Biokern. Hergestellt mit umweltschonenden Sojaölen.

Atmungsaktiv und hygienisch. Eingebaute Luftkanäle, damit das Baby immer frisch und trocken schläft. Einfache Reinigung. Durch den rundherumgehenden Reissverschluss kann die Hülle einfach abgezogen werden.

## Materasso in Bio Soia per bambini prodotto con oli essenziali di soia.

Tessuto in cotone organico. Certificato "Organic Cotton" che permette al bimbo di dormire su un materasso rivestito in morbido cotone naturale derivante da coltivazioni ecologiche, prive di pesticidi e di sostanze nocive.

Prevenzione della morte improvvisa. Materasso progettato secondo le raccomandazioni per prevenire la morte improvvisa del lattante.

Nucleo in Bio Soia. Prodotto con oli essenziali di soia di origine vegetale, rispettando la natura.

Massima traspirabilità ed igiene. I suoi canali di aerazione mantengono il bimbo sempre fresco e asciutto. Lavaggio facile, la sua chiusura lampo perimetrale consente il lavaggio di ogni singolo componente senza che essi perdano le loro proprietà.

**Reference**  
Referencia  
Référence  
Referenz  
Riferimento

**Cot size**  
Medidas cuna  
Mesures du lit bébé  
Maße Babybett  
Misure lettino

**Mattress size**  
Medidas del colchón  
Mesures du matelas  
Maße Matratze  
Misure materasso

ZR60-120

60x 120 cm

58x 118x 12 cm

ZR70-140

70x 140 cm

68x 138x 12 cm

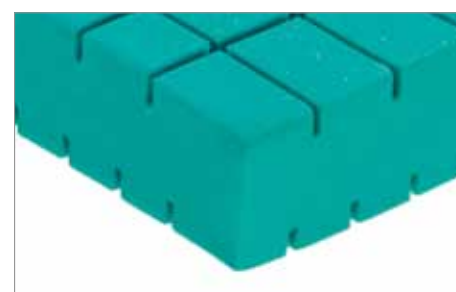
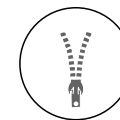
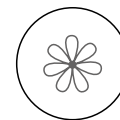
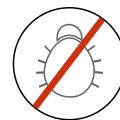
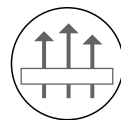



# MEMORY VISCO

MATTRESSES | COLCHONES | MATELAS | MATRATZE | MATERASSI

## Body-adaptable memory foam mattress.

**Body-adaptable.**  
Memory foam is a material that adapts to the baby's or child's body and relieves any type of pressure on the body during sleep.

**Hygiene and comfort.**  
The mattress composition ensures maximum comfort, breathability and durability. Hypoallergenic and dust mite resistant.

**Soft cover.**  
The mattress cover has a lovely soft feel. Made of OEKO-TEX® Standard 100 stretch fabric.

**Removable and washable cover.**  
Easy-clean. The mattress features a cover that can be easily taken off by undoing the zipper.

## Colchón de viscoelástica adaptable, para el correcto descanso del bebé.

**Adaptable.**  
Fabricado con viscoelástica, material que se adapta al cuerpo del bebé o niño evitando cualquier punto de presión durante el descanso.

**Higiene y confort.**  
La composición del colchón asegura la máxima comodidad, transpirabilidad y duración del mismo. Incorpora tratamientos anti ácaros para evitar alergias.

**Tejido suave.**  
El tejido exterior del colchón ofrece una agradable sensación de suavidad. Compuesto por tejido "Stretch" certificado OEKO-TEX® estándar 100.

**Desenfundable y lavable.**  
Colchón higiénico. Fácil de desenfundar gracias a la cremallera perimetral que incorpora.

## Matelas en mousse viscoélastique adaptable.

**Adaptable.**  
Fabriqué en mousse à mémoire de forme, qui s'adapte à la morphologie du corps du bébé ou de l'enfant, allégeant ainsi les points de pression pendant le sommeil.

**Hygiénique et confortable.**  
La composition du matelas assure son confort, transpirabilité et durabilité. Traité contre les acariens afin d'éviter des allergies.

**Tissu doux.**  
La housse du matelas offre une sensation douce et moelleuse. Housse en tissu "Stretch" certifié OEKO-TEX® Standard 100.

**Matelas déhoussable.**  
Hygiénique et facile d'entretien. Housse amovible à fermeture éclair et lavable.



## Matratze aus Viscoschaum, für den gesunden Schlaf des Kindes.

**Anpassung.**  
Hergestellt aus Viscoschaum. Dieses Material passt sich perfekt an dem Körper des Kindes an, ohne jeglichen Druckpunkte zu verursachen.

**Hygiene und Komfort.**  
Die Zusammensetzung der Matratze garantiert maximalen Komfort, beste Belüftung und eine lange Nutzung. Die Matratze wurde gegen Milben behandelt und ist somit für Allergiker geeignet.

**Weicher Stoff.**  
Der äussere Stoff der Matratze, hergestellt nach OEKO-TEX® Standard 100, ist angenehm weich.

**Abzieh- und waschbar.**  
Der Matratzenbezug ist mit einem Reißverschluss versehen und kann abgezippt werden.

## Materasso anatomico viscoelastico, per un sano e corretto riposo del bimbo.

**Anatomico.**  
Prodotto in schiuma viscoelastica, materiale che con il calore prende la forma del corpo del bimbo evitando qualsiasi punto di pressione durante il riposo.

**Igiene e confort.**  
La composizione del materasso garantisce la massima comodità, traspirabilità e durata dello stesso. Il trattamento antiacaro previene eventuali reazioni allergiche.

**Morbido tessuto.**  
Il tessuto esterno del materasso offre una gradevole sensazione di morbidezza. Prodotto in tessuto "Stretch" certificato OEKO-TEX® standard 100.

**Sfoderabile e lavabile.**  
Materasso igienico. Facile da sfoderare grazie alla pratica chiusura zip perimetrale.

Reference Referencia Référence Referenz Riferimento	Bed / cot size Medidas cuna / cama Mesures du lit bébé / junior Maße Baby-/Jugendbett Misure lettino / letto	Mattress size Medidas del colchón Mesures du matelas Maße Matratze Misure materasso
ZC90-200	90 x 200 cm	90 x 200 x 22 cm
ZN90-190	90 x 190 cm	90 x 190 x 15 cm
ZV60-120	60 x 120 cm	58 x 118 x 12 cm
ZV70-140	70 x 140 cm	68 x 138 x 12 cm
ZY50-80	50 x 80 cm	53 x 80 x 5 cm

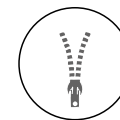
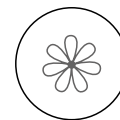
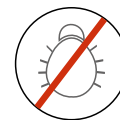
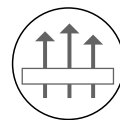
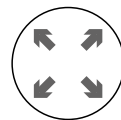

**Rolled up for easier transport**  
Enrollado para facilitar el transporte  
Enroulé pour un transport facile  
Gerollt für einfachen Transport  
Arrotolato per facilitarne il trasporto



# VINYLS

ACCESSORIES | ACCESORIOS | ACCESSOIRES | ZUBEHÖR | ACCESSORI

## Y1D / Y2D Hearts vinyl | Vinilo corazones | Sticker coeurs | Aufkleber Herzen | Vinile cuori

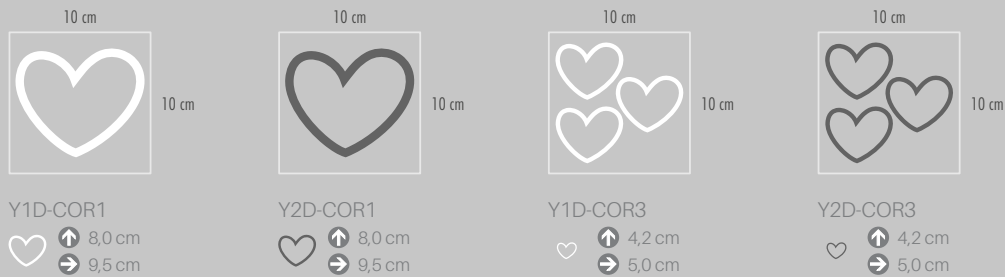

## Y1D / Y2D Butterflies vinyl | Vinilo mariposas | Sticker papillons | Aufkleber Schmetterlinge | Vinile Farfalle

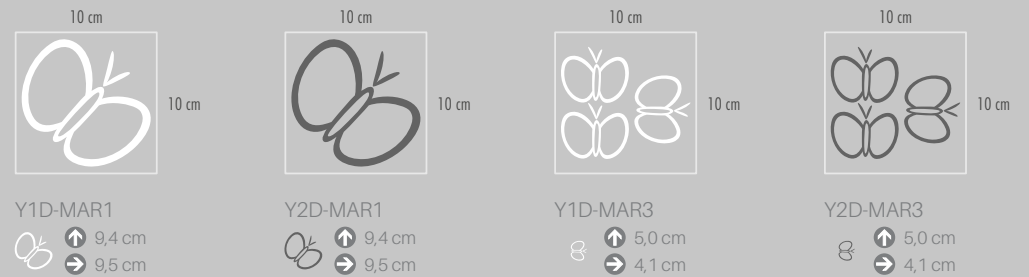

## Y1D / Y2D Stars vinyl | Vinilo estrellas | Sticker étoiles | Aufkleber Sterne | Vinile stelle

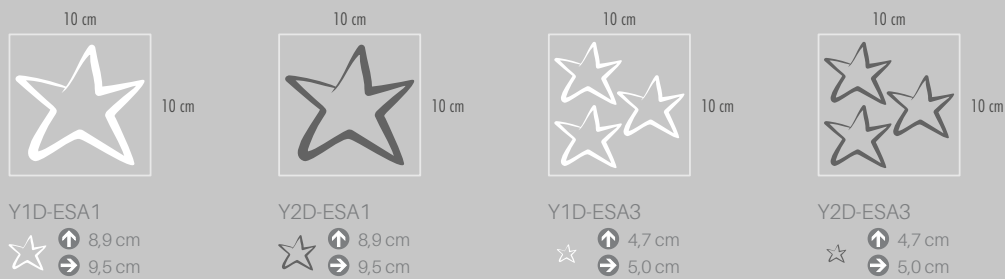

## Y1D / Y2D Stars vinyl | Vinilo estrellas | Sticker étoiles | Aufkleber Sterne | Vinile stelle

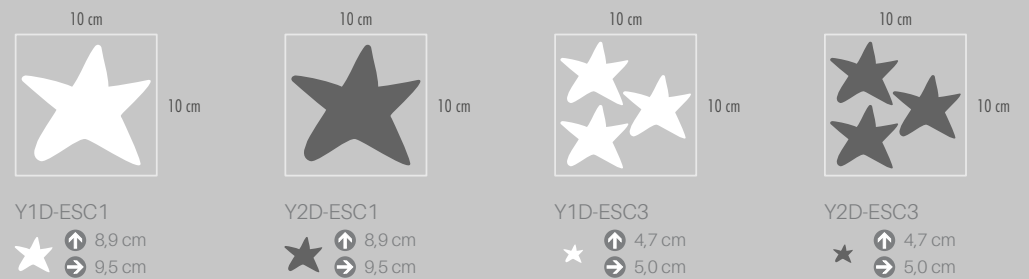

## Y1D / Y2D Flowers vinyl | Vinilo flores | Sticker fleurs | Aufkleber Blumen | Vinile fiori

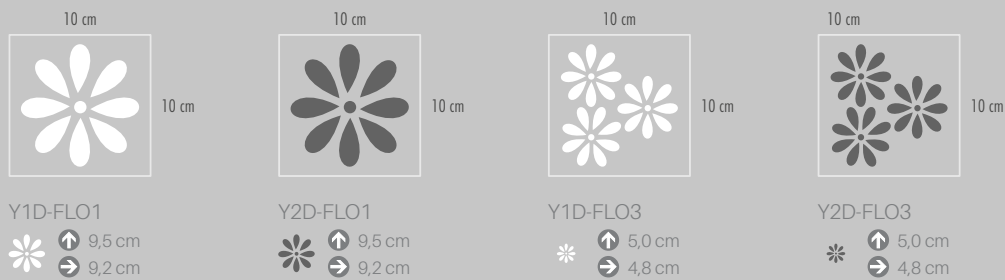

## Y1S / Y2S Sun vinyl | Vinilo sol | Sticker soleil | Aufkleber Sonne | Vinile sole

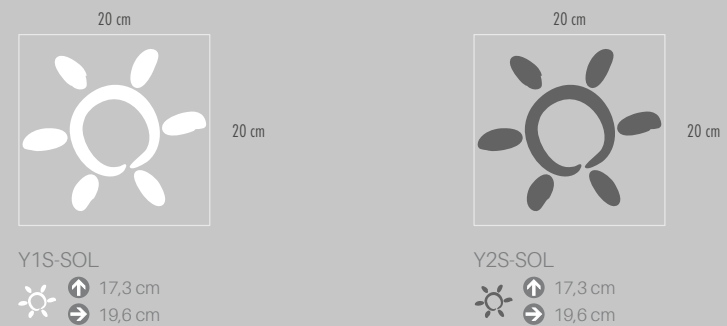

## Y1G / Y2G Cloud vinyl | Vinilo nube | Sticker nuage | Aufkleber Wolke | Vinile nuvola

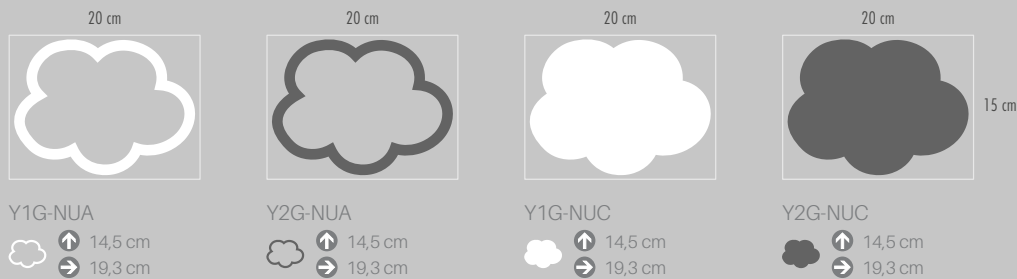

## Y1G / Y2G Moon vinyl | Vinilo luna | Sticker lune | Aufkleber Mond | Vinile luna

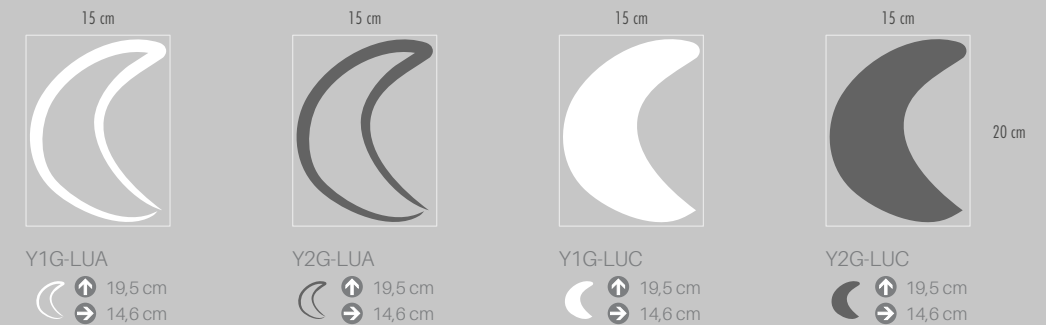

## Y1 White vinyl letters | Letras vinilo blanco | Lettres autocollantes blanches | Buchstaben Aufkleber weiss | Lettere vinile bianco



## Y2 Gray vinyl letters | Letras vinilo gris | Lettres autocollantes grises | Buchstaben Aufkleber grau | Lettere vinile grigio



# NURSING CHAIRS

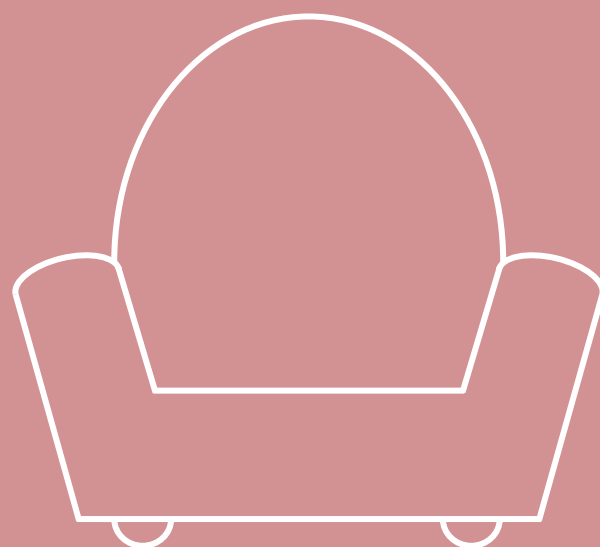

**NURSING CHAIRS | SILLONES DE LACTANCIA**  
FAUTEUILS D'ALLAITEMENT | *STILLSESSEL* | POLTRONE ALLATTAMENTO

**NURSING CHAIRS | SILLONES DE LACTANCIA**  
 FAUTEUILS D'ALLAITEMENT | *STILLSESSEL* | POLTRONE ALLATTAMENTO

Leatherette | Polipiel | Similicuir | *Kunstleder* | Ecopelle



SL100P-P153



SL100P-P178



SL100P-P915



SL100P-P977

Leatherette | Polipiel | Similicuir | *Kunstleder* | Ecopelle



SL100P-P979



SL100A-A901

Fabric | Tela | Tissu | *Stoff* | Tessile



SL100T-T923



SL100T-T939

**DETAILS | DETALLES | DÉTAILS | DETAILS | DETTAGLI**



**Rocking function**  
 Posición balancín  
 Position balancelle  
*Schaukelstuhl* Position  
 Posizione dondolo



**Fixed base. Includes 4 feet.**  
 Posición fija. Incluye 4 patas.  
 Position fixe. Includ 4 pieds.  
*Sessel* Position. Inklusiv 4 Füße.  
 Posizione fissa. Include 4 piedini.

**MEASURES | MEDIDAS**  
 MESURES | *MAßE* | MISURE

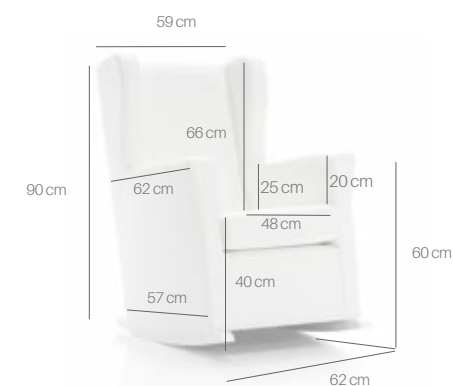



**NURSING CHAIRS | SILLONES DE LACTANCIA**  
 FAUTEUILS D'ALLAITEMENT | *STILLSESSEL* | POLTRONE ALLATTAMENTO

Leatherette | Polipiel | Similicuir | *Kunstleder* | Ecopelle



ERGO  
SL101P-P153

ERGO PLUS +  
SL102P-P153



ERGO  
SL101P-P178

ERGO PLUS +  
SL102P-P178



ERGO  
SL101P-P915

ERGO PLUS +  
SL102P-P915



ERGO  
SL101P-P977

ERGO PLUS +  
SL102P-P977

Leatherette | Polipiel | Similicuir | *Kunstleder* | Ecopelle



ERGO  
SL101P-P979

ERGO PLUS +  
SL102P-P979



ERGO  
SL101A-A901

ERGO PLUS +  
SL102A-A901

Fabric | Tela | Tissu | Stoff | Tessile



ERGO  
SL101T-T923

ERGO PLUS +  
SL102T-T923



ERGO  
SL101T-T939

ERGO PLUS +  
SL102T-T939

**DETAILS | DETALLES | DÉTAILS | DETAILS | DETTAGLI**



**Rocking function**  
 Posición balancín  
 Position balancelle  
*Schaukelstuhl* Position  
 Posizione dondolo



**Fixed base. Includes 4 feet.**  
 Posición fija. Incluye 4 patas.  
 Position fixe. Includ 4 pieds.  
*Sessel* Position. Inklusive 4 Füße.  
 Posizione fissa. Include 4 piedini.

**MEASURES | MEDIDAS | MESURES | MAßE | MISURE**

**ERGO**



**ERGO PLUS +**





# ERGO LUXE

NURSING CHAIRS | SILLONES DE LACTANCIA  
FAUTEUILS D'ALLAITEMENT | STILLSESSEL | POLTRONE ALLATTAMENTO

Leatherette | Polipiel | Similicuir | Kunstleder | Ecopelle



ERGO LUXE  
SL111P-P915



ERGO LUXE PLUS +  
SL112P-P915



ERGO LUXE  
SL111P-P979



ERGO LUXE PLUS +  
SL112P-P977



ERGO LUXE PLUS +  
SL112P-P979

## DETAILS | DETALLES | DÉTAILS | DETAILS | DETTAGLI



**LED Lamp**  
Lámpara de LED  
Lampe LED  
LED Lampe  
Lampada a LED



**Includes transformer**  
Incluye transformador  
Inclut transformateur  
Inklusive Transformator  
Include trasformatore



**Neck pillow. Height adjustable (magnet).**  
Cojín para el cuello. Ajustable en altura con imán.  
Repose nuque. Réglable en hauteur (aimant).  
Nackenkissen - Höhenverstellbar mit Magnet.  
Cuscino poggiatesta. Regolabile in altezza con calamita.

**Lumbar pillow with removable cover.**  
Cojín lumbar desenfundable.  
Coussin lombaire déhoussable.  
Rückenkissen abziehbar.  
Cuscino lombare sfoderabile.



**2 USB charging sockets**  
2 tomas de USB  
2 prises USB  
2 USB-Anschlüsse  
2 prese USB

**Measures | Medidas**  
Mesures | Maße | Misure

2  
SIZES

### ERGO LUXE

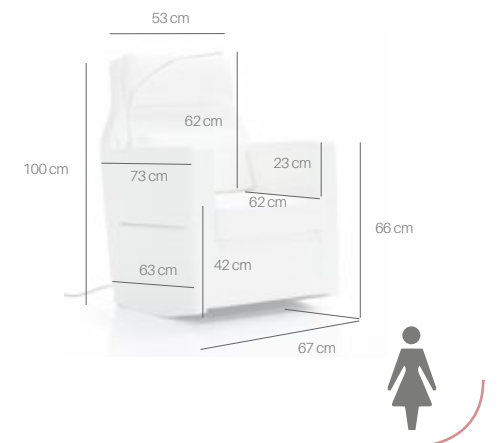

### ERGO LUXE PLUS +

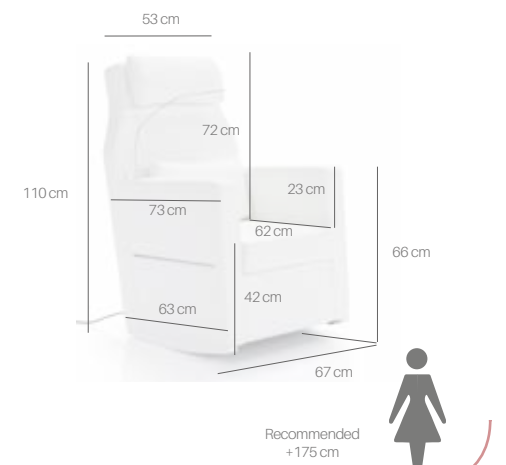

2 positions | 2 posiciones | 2 positions | 2 Positionen | 2 posizioni



**Rocking function.**  
Posición balancín.  
Position balancelle.  
Schaukelstuhl Position.  
Posizione dondolo.



**Fixed base. Includes 4 feet.**  
Posición fija. Incluye 4 patas.  
Position fixe. Inclut 4 pieds.  
Sessel Position. Inklusive 4 Füße.  
Posizione fissa. Include 4 piedini.





SP105P-P153



SP105P-P178



SP105P-P915



SP105P-P977



SP105P-P979



SP105A-A901



SP105T-T923



SP105T-T939

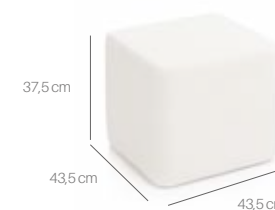



**Number of pieces**  
**Número de piezas**  
Nombre de pièces  
*Anzahl der Teile*  
Numero di pezzi



**Removable without zipper**  
**Desenfundable sin cremallera**  
Déhoussable sans fermeture éclair  
*Abziehbar ohne Reißverschluss*  
Sfoderabile senza chiusura zip



**Removable with zipper**  
**Desenfundable con cierre de cremallera**  
Déhoussable avec fermeture éclair  
*Abziehbar mit Reißverschluss*  
Sfoderabile con chiusura zip



**Number of pennants**  
**Número de banderines**  
Nombre de banderoles  
*Anzahl der Wimpel*  
Numero di bandierine



**Double-sided for winter & summer**  
**Doble cara. Invierno-verano**  
Double face hiver-été  
*Winter -und Sommerseite*  
Double face inverno-estate

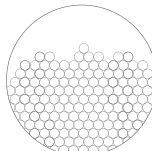

**Polystyrene beads filling**  
**Relleno con perlas de poliestireno**  
Rembourrage billes de polystyrène  
*Füllung aus Polystyrenkugeln*  
Imbottito con perle di polistirolo



**Velcro closure**  
**Cierre con velcro**  
Fermeture en scratch  
*Klettverschluss*  
Chiusura velcro

# TEXTILES

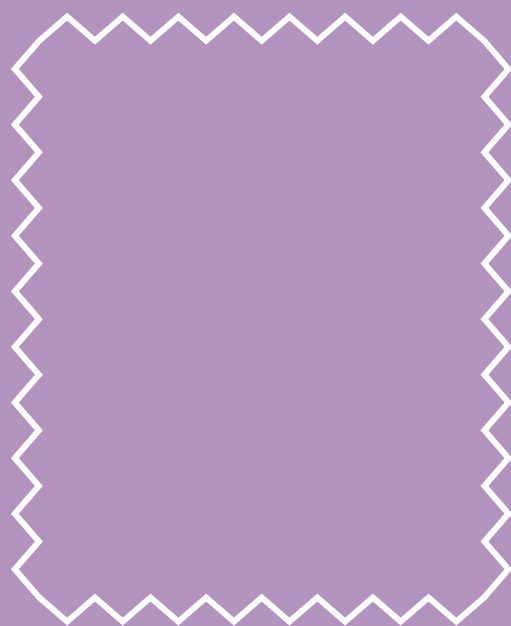

**TEXTILES** | TEXTILES | LAYETTE | *TEXTILIEN* | TESSILE

**689-055**

36 x 43 x 12 cm

**Kids cushion · Mountains**  
Cojín infantil · Montañas  
Coussin enfant · Montagnes  
Kinder-Kissen · Berge  
Cuscino decorativo · Montagna



**691-055**

36 x 32 x 10 cm

**Kids cushion · Teepee tent**  
Cojín infantil · Tipi  
Coussin enfant · Tipi  
Kinder-Kissen · Tipi  
Cuscino decorativo · Tenda



**692E-055**

35 x 43 x 11 cm

**Kids cushion · Triangle**  
Cojín infantil · Triángulo  
Coussin enfant · Triangle  
Kinder-Kissen · Dreieck  
Cuscino decorativo · Triangolo



**690E-055**

35 x 35 x 15 cm

**Square cushion with removable cover**  
Cojín infantil cuadrado desfundable  
Coussin carré déhoussable  
Quadratisches Kissen (abziehbar)  
Cuscino quadrato sfoderabile



**694-055**

▼ 18 x 12 cm

**Garland-pennants (2,50 m long)**  
Guirnalda-banderines infantiles (2,50 m largo)  
Guirlande-banderole (2,50 m longueur)  
Stoff-Girlande (2,50 m lang)  
Ghirlanda-bandierine (2,50 m. lunghezza)

▼  
x16



**693-055**

☆ 34 x 34 x 10 cm    ♥ 20 x 20 x 8 cm    ☾ 26 x 20 x 8 cm

**Set 3 decorative cushions**  
Set 3 cojines infantiles decoración  
Set 3 coussins décoratifs  
Set 3 Dekokissen  
Set 3 cuscini da decorazione

Set  
3  
pieces



**618-055**

21 x 30 x 20 cm

**Padded baby toiletries basket**  
Cesta colonias infantil acolchada  
Panier matelassé pour produits de soin  
Gefütterter Stoffkorb für Badeartikel  
Cestino portasaponi trapuntato



**619-055**

41 x 34 x 34 cm

**Padded fabric storage basket**  
Saco de juguetes textil acolchado  
Panier de rangement matelassé  
Gefütterter Korb für Spielwaren  
Sacco portagiocchi trapuntato



**631-055**

15 x 60 x 90 cm

**Top changer for Konver 70x140 and chest**  
Vestidor para Konver 70x140 y cómoda  
Matelas à langer pour Konver 70x140 et commode  
Wickelauflage für Konver 70x140 und Kommode  
Fasciatoio Konver 70x140 e cassetiera



**633-055\***

10 x 51 x 82 cm

**Bath changer cover without foam**  
Funda vestidor sin espuma para bañeras  
Housse supplémentaire sans mousse pour baignoires  
Bezug für Wickelauflage ohne Schaumstoff für Waschtisch  
Fodera fasciatoio (senza materassino) per bagnetti



**634-055**

8 x 46 x 65 cm

**Top changer for Konver 60x120**  
Vestidor para Konver 60x120  
Matelas à langer pour Konver 60x120  
Wickelauflage für Konver 60x120  
Fasciatoio Konver 60x120



**698-055**

▭ 8 x 29 x 26 cm    ▭ 8 x 42 x 26 cm

**Sleep positioner with removable cover**  
Cojín Antivelcro bebé desfundable  
Cale-bébé déhoussable  
Seitenschläferkissen (abziehbar)  
Riduttore dormiscuro sfoderabile



\* Inside foam ref. R-VE1 not included | Espuma interior Ref. R-VE1, no incluida  
Mousse intérieure Réf. R-VE1 pas incluse | Wickelauflage Ref. R-VE1 nicht inklusive | Materassino Rif. R-VE1, non incluso

Sizes | Medidas | Misure | Wisure | Misure ↻ ↷ ↸

# MINT 055



**606-055** 90 x 140 cm  
**626-055** 105 x 165 cm  
**636-055** 150 x 220 cm

**Duvet cover (with duvet)**  
**Nórdico (con relleno)**  
 Housse et couette  
*Bettbezug (mit Decke)*  
 Piumino nordico (con imbottitura)



**670-055** 67 x 94 x 65 cm  
**Crib (colour 77 white matte)**  
**Minicuna (color 77 blanco mate)**  
 Berceau (couleur 77 blanc mat)  
*Stubenwagen (Farbe 77 Weiss matt)*  
 Culla (colore 77 bianco opaco)



**Co-sleeping crib & textile set (+ info pages 4-9)**  
**Minicuna de colecho y Kit textil (+ info págs. 4-9)**  
 Berceau cododo + kit textile (+ info pages 4-9)  
*Beistellbett + Textil-Set (+ Info auf Seiten 4-9)*  
 Culla fianco letto + pack tessile (+ info pages. 4-9)

**606F-055** 90 x 140 cm  
**626F-055** 105 x 165 cm  
**636F-055** 150 x 220 cm

**Duvet cover (without duvet)**  
**Funda nórdica (sin relleno)**  
 Housse pour couette  
*Bettbezug (ohne Decke)*  
 Sacco nordico (senza imbottitura)

**607-055** 180 x 44 cm  
**627-055** 210 x 44 cm

**Bumper Protector**  
 Tour de lit  
*Nestchen*  
 Paracolpi



**696-055** 15 x 55 x 50 cm  
**Nursing pillow with removable cover (cover + pad)**  
**Cojín de lactancia desenfundable (funda + relleno)**  
 Coussin d'allaitement déhoussable (housse + gamissage)  
*Stillkissen - abziehbar (Bezug + Füllung)*  
 Cuscino allattamento sfoderabile (fodera + imbottitura)



**647-055** 115 x 115 cm  
**Carpet for tepee tent**  
**Alfombra para Tipi infantil**  
 Tapis pour tipi  
*Teppich für Tipi- Kinderzelt*  
 Tappeto per tenda indiana



**612-055** 110 x 150 cm  
**632-055** 135 x 175 cm

**Cot sheets set - 3 pieces (100% Cotton)**  
**Sábanas cuna - 3 piezas (100% Algodón)**  
 Parure de lit - 3 pièces (100% Coton)  
*Bettwäsche - 3 tlg. (100% Baumwolle)*  
 Lenzuola lettino - 3 pezzi (100% Cotone)



**697C-055** 15 x 114 x 58 cm  
**Large pregnancy pillow (cover + pad)**  
**Cojín de maternidad (funda + relleno)**  
 Coussin de maternité (housse + gamissage)  
*Schwangerschaftskissen (Bezug + Füllung)*  
 Cuscino premaman grande (fodera + imbottitura)



**646-055** 132 x 115 x 115 cm  
**Kids tepee tent**  
**Tipi infantil**  
 Tipi enfant  
*Tipi- Kinderzelt*  
 Tenda indiana



**616-055** 95 x 122 cm  
**Crib sheets set - 3 pieces (100% Cotton)**  
**Sábanas minicuna - 3 piezas (100% Algodón)**  
 Parure de berceau - 3 pièces (100% Coton)  
*Bettwäsche für Wiege 3-tlg. (100% Baumwolle)*  
 Lenzuola culla - 3 pezzi (100% Cotone)

Set  
**3**  
 pieces

**689-111**

36 x 43 x 12 cm

**Kids cushion · Mountains**  
Cojín infantil · Montañas  
Coussin enfant · Montagnes  
Kinder-Kissen · Berge  
Cuscino decorativo · Montagna



**691-111**

36 x 32 x 10 cm

**Kids cushion · Teepee tent**  
Cojín infantil · Tipi  
Coussin enfant · Tipi  
Kinder-Kissen · Tipi  
Cuscino decorativo · Tenda



**692E-111**

35 x 43 x 11 cm

**Kids cushion · Triangle**  
Cojín infantil · Triángulo  
Coussin enfant · Triangle  
Kinder-Kissen · Dreieck  
Cuscino decorativo · Triangolo



**692L-901**  
Blue | Celeste  
Bleu | Blau | Celeste

**690E-111**

35 x 35 x 15 cm

**Square cushion with removable cover**  
Cojín infantil cuadrado desfundable  
Coussin carré déhoussable  
Quadratisches Kissen (abziehbar)  
Cuscino quadrato sfoderabile



**690L-111**  
Blue | Celeste  
Bleu | Blau | Celeste

**694-111**

▼ 18 x 12 cm

**Garland-pennants (2,50 m long)**  
Guiraldas-banderines infantiles (2,50 m largo)  
Guirlande-banderole (2,50 m longueur)  
Stoff-Girlande (2,50 m lang)  
Ghirlanda-bandierine (2,50 m. lunghezza)

▼  
x16



**693-111**

☆ 34 x 34 x 10 cm ♥ 20 x 20 x 8 cm ☾ 26 x 20 x 8 cm

**Set 3 decorative cushions**  
Set 3 cojines infantiles decoración  
Set 3 coussins décoratifs  
Set 3 Dekokissen  
Set 3 cuscini da decorazione

Set  
3  
pieces



**618-111**

21 x 30 x 20 cm

**Padded baby toiletries basket**  
Cesta colonias infantil acolchada  
Panier matelassé pour produits de soin  
Gefütterter Stoffkorb für Badeartikel  
Cestino portasaponi trapuntato



**619-111**

41 x 34 x 34 cm

**Padded fabric storage basket**  
Saco de juguetes textil acolchado  
Panier de rangement matelassé  
Gefütterter Korb für Spielwaren  
Sacco portagiocchi trapuntato



**631-111**

15 x 60 x 90 cm

**Top changer for Konver 70x140 and chest**  
Vestidor para Konver 70x140 y cómoda  
Matelas à langer pour Konver 70x140 et commode  
Wickelaufgabe für Konver 70x140 und Kommode  
Fasciatoio Konver 70x140 e cassetiera



**633-111\***

10 x 51 x 82 cm

**Bath changer cover without foam**  
Funda vestidor sin espuma para bañeras  
Housse supplémentaire sans mousse pour baignoires  
Bezug für Wickelaufgabe ohne Schaumstoff für Waschtisch  
Fodera fasciatoio (senza materassino) per bagnetti



**634-111**

8 x 46 x 65 cm

**Top changer for Konver 60x120**  
Vestidor para Konver 60x120  
Matelas à langer pour Konver 60x120  
Wickelaufgabe für Konver 60x120  
Fasciatoio Konver 60x120



**698-111**

☐ 8 x 29 x 26 cm ☐ 8 x 42 x 26 cm

**Sleep positioner with removable cover**  
Cojín Antivelcro bebé desfundable  
Cale-bébé déhoussable  
Seitenschläferkissen (abziehbar)  
Riduttore dormisicuro sfoderabile



\* Inside foam ref. R-VE1 not included | Espuma interior Ref. R-VE1, no incluida  
Mousse intérieure Réf. R-VE1 pas incluse | Wickelaufgabe Ref. R-VE1 nicht inklusive | Materassino Rif. R-VE1, non incluso

# INDIANA BLU 111



60x120

**606-111**

90 x 140 cm

**Duvet cover (with duvet)**  
**Nórdico (con relleno)**  
 Housse et couette  
*Bettbezug (mit Decke)*  
 Plumino nordico (con imbottitura)

70x140

**626-111**

105 x 165 cm

90x200

**636-111**

150 x 220 cm



60x120

**606F-111**

90 x 140 cm

**Duvet cover (without duvet)**  
**Funda nórdica (sin relleno)**  
 Housse pour couette  
*Bettbezug (ohne Decke)*  
 Sacco nordico (senza imbottitura)

70x140

**626F-111**

105 x 165 cm

90x200

**636F-111**

150 x 220 cm

**670-111**

67 x 94 x 65 cm

**Crib (colour 77 white matte)**  
**Minicuna (color 77 blanco mate)**  
 Berceau (couleur 77 blanc mat)  
*Stubenwagen (Farbe 77 Weiss matt)*  
 Culla (colore 77 bianco opaco)



**Co-sleeping crib & textile set (+ info pages 4-9)**  
**Minicuna de colecho y Kit textil (+ info págs. 4-9)**  
 Berceau cododo + kit textile (+ info pages 4-9)  
*Beistellbett + Textil-Set (+ Info auf Seiten 4-9)*  
 Culla fianco letto + pack tessile (+ info pages. 4-9)

60x120

**607-111**

180 x 44 cm

**Bumper Protector**  
 Tour de lit  
*Nestchen*  
 Paracolpi



70x140

**627-111**

210 x 44 cm



**696-111**

15 x 55 x 50 cm

**Nursing pillow with removable cover (cover + pad)**  
**Cojín de lactancia desenfundable (funda + relleno)**  
 Coussin d'allaitement déhoussable (housse + gamissage)  
*Stillkissen - abziehbar (Bezug + Füllung)*  
 Cuscino allattamento sfoderabile (fodera + imbottitura)



**647-111**

115 x 115 cm

**Carpet for tepee tent**  
**Alfombra para Tipi infantil**  
 Tapis pour tipi  
*Teppich für Tipi- Kinderzelt*  
 Tappeto per tenda indiana



60x120

**612-111**

110 x 150 cm

**Cot sheets set - 3 pieces (100% Cotton)**  
**Sábanas cuna - 3 piezas (100% Algodón)**  
 Parure de lit - 3 pièces (100% Coton)  
*Bettwäsche - 3 tlg. (100% Baumwolle)*  
 Lenzuola lettino - 3 pezzi (100% Cotone)

70x140

**632-111**

135 x 175 cm

**616-111**

95 x 122 cm

**Crib sheets set - 3 pieces (100% Cotton)**  
**Sábanas minicuna - 3 piezas (100% Algodón)**  
 Parure de berceau - 3 pièces (100% Coton)  
*Bettwäsche für Wiege 3-tlg. (100% Baumwolle)*  
 Lenzuola culla - 3 pezzi (100% Cotone)



**697C-111**

15 x 114 x 58 cm

**Large pregnancy pillow (cover + pad)**  
**Cojín de maternidad (funda + relleno)**  
 Coussin de maternité (housse + gamissage)  
*Schwangerschaftskissen (Bezug + Füllung)*  
 Cuscino premaman grande (fodera + imbottitura)



**646-111**

132 x 115 x 115 cm

**Kids tepee tent**  
**Tipi infantil**  
 Tipi enfant  
*Tipi- Kinderzelt*  
 Tenda indiana



Set  
3  
pieces

**689-112**

36 x 43 x 12 cm

**Kids cushion · Mountains**  
Cojín infantil · Montañas  
Coussin enfant · Montagnes  
Kinder-Kissen · Berge  
Cuscino decorativo · Montagna



**691-112**

36 x 32 x 10 cm

**Kids cushion · Teepee tent**  
Cojín infantil · Tipi  
Coussin enfant · Tipi  
Kinder-Kissen · Tipi  
Cuscino decorativo · Tenda



**692E-112**

35 x 43 x 11 cm

**Kids cushion · Triangle**  
Cojín infantil · Triángulo  
Coussin enfant · Triangle  
Kinder-Kissen · Dreieck  
Cuscino decorativo · Triangolo



**692L-902**  
Pink | Rosa  
Rose | Rosa | Rosa

**690E-112**

35 x 35 x 15 cm

**Square cushion with removable cover**  
Cojín infantil cuadrado desfundable  
Coussin carré déhoussable  
Quadratisches Kissen (abziehbar)  
Cuscino quadrato sfoderabile



**690L-112**  
Pink | Rosa  
Rose | Rosa | Rosa

**694-112**

▼ 18 x 12 cm

**Garland-pennants (2,50 m long)**  
Guiraldas-banderines infantiles (2,50 m largo)  
Guirlande-banderole (2,50 m longueur)  
Stoff-Girlande (2,50 m lang)  
Ghirlanda-bandierine (2,50 m. lunghezza)



**693-112**

☆ 34 x 34 x 10 cm ♥ 20 x 20 x 8 cm ☾ 26 x 20 x 8 cm

**Set 3 decorative cushions**  
Set 3 cojines infantiles decoración  
Set 3 coussins décoratifs  
Set 3 Dekokissen  
Set 3 cuscini da decorazione



**618-112**

21 x 30 x 20 cm

**Padded baby toiletries basket**  
Cesta colonias infantil acolchada  
Panier matelassé pour produits de soin  
Gefütterter Stoffkorb für Badeartikel  
Cestino portasaponi trapuntato



**619-112**

41 x 34 x 34 cm

**Padded fabric storage basket**  
Saco de juguetes textil acolchado  
Panier de rangement matelassé  
Gefütterter Korb für Spielwaren  
Sacco portagiocchi trapuntato



**631-112**

15 x 60 x 90 cm

**Top changer for Konver 70x140 and chest**  
Vestidor para Konver 70x140 y cómoda  
Matelas à langer pour Konver 70x140 et commode  
Wickelaufgabe für Konver 70x140 und Kommode  
Fasciatoio Konver 70x140 e cassetiera



**633-112\***

10 x 51 x 82 cm

**Bath changer cover without foam**  
Funda vestidor sin espuma para bañeras  
Housse supplémentaire sans mousse pour baignoires  
Bezug für Wickelaufgabe ohne Schaumstoff für Waschtisch  
Fodera fasciatoio (senza materassino) per bagnetti



**634-112**

8 x 46 x 65 cm

**Top changer for Konver 60x120**  
Vestidor para Konver 60x120  
Matelas à langer pour Konver 60x120  
Wickelaufgabe für Konver 60x120  
Fasciatoio Konver 60x120



**698-112**

☐ 8 x 29 x 26 cm ☐ 8 x 42 x 26 cm

**Sleep positioner with removable cover**  
Cojín Antivuelco bebé desfundable  
Cale-bébé déhoussable  
Seitenschläferkissen (abziehbar)  
Riduttore dormisicuro sfoderabile



\* Inside foam ref. R-VE1 not included | Espuma interior Ref. R-VE1, no incluida  
Mousse intérieure Réf. R-VE1 pas incluse | Wickelaufgabe Ref. R-VE1 nicht inklusive | Materassino Rif. R-VE1, non incluso



# INDIANA ROSA 112



60x120

**606-112**

90 x 140 cm

**Duvet cover (with duvet)**  
Nórdico (con relleno)  
Housse et couette  
Bettbezug (mit Decke)  
Piumino nordico (con imbottitura)

70x140

**626-112**

105 x 165 cm

90x200

**636-112**

150 x 220 cm



60x120

**606F-112**

90 x 140 cm

**Duvet cover (without duvet)**  
Funda nórdica (sin relleno)  
Housse pour couette  
Bettbezug (ohne Decke)  
Sacco nordico (senza imbottitura)

70x140

**626F-112**

105 x 165 cm

90x200

**636F-112**

150 x 220 cm

**670-112**

67 x 94 x 65 cm

**Crib (colour 77 white matte)**  
Minicuna (color 77 blanco mate)  
Berceau (couleur 77 blanc mat)  
Stubenwagen (Farbe 77 Weiss matt)  
Culla (colore 77 bianco opaco)



**Co-sleeping crib & textile set (+ info pages 4-9)**  
Minicuna de colecho y Kit textil (+ info págs. 4-9)  
Berceau cododo + kit textile (+ info pages 4-9)  
Beistellbett + Textil-Set (+ Info auf Seiten 4-9)  
Culla fianco letto + pack tessile (+ info pages. 4-9)

60x120

**607-112**

180 x 44 cm

**Bumper Protector**  
Tour de lit  
Nestchen  
Paracolpi



70x140

**627-112**

210 x 44 cm



**696-112**

15 x 55 x 50 cm

**Nursing pillow with removable cover (cover + pad)**  
Cojín de lactancia desenfundable (funda + relleno)  
Coussin d'allaitement déhoussable (housse + garnissage)  
Stillkissen - abziehbar (Bezug + Füllung)  
Cuscino allattamento sfoderabile (fodera + imbottitura)



**647-112**

115 x 115 cm

**Carpet for tepee tent**  
Alfombra para Tipi infantil  
Tapis pour tipi  
Teppich für Tipi- Kinderzelt  
Tappeto per tenda indiana



60x120

**612-112**

110 x 150 cm

**Cot sheets set - 3 pieces (100% Cotton)**  
Sábanas cuna - 3 piezas (100% Algodón)  
Parure de lit - 3 pièces (100% Coton)  
Bettwäsche - 3 tlg. (100% Baumwolle)  
Lenzuola lettino - 3 pezzi (100% Cotone)

70x140

**632-112**

135 x 175 cm

**616-112**

95 x 122 cm

**Crib sheets set - 3 pieces (100% Cotton)**  
Sábanas minicuna - 3 piezas (100% Algodón)  
Parure de berceau - 3 pièces (100% Coton)  
Bettwäsche für Wiege 3-tlg. (100% Baumwolle)  
Lenzuola culla - 3 pezzi (100% Cotone)



**697C-112**

15 x 114 x 58 cm

**Large pregnancy pillow (cover + pad)**  
Cojín de maternidad (funda + relleno)  
Coussin de maternité (housse + garnissage)  
Schwangerschaftskissen (Bezug + Füllung)  
Cuscino premaman grande (fodera + imbottitura)



**646-112**

132 x 115 x 115 cm

**Kids tepee tent**  
Tipi infantil  
Tipi enfant  
Tipi- Kinderzelt  
Tenda indiana



Set  
3  
pieces

**689-140**

36 x 43 x 12 cm

**Kids cushion · Mountains**  
Cojin infantil · Montañas  
Coussin enfant · Montagnes  
Kinder-Kissen · Berge  
Cuscino decorativo · Montagna



**691-140**

36 x 32 x 10 cm

**Kids cushion · Teepee tent**  
Cojin infantil · Tipi  
Coussin enfant · Tipi  
Kinder-Kissen · Tipi  
Cuscino decorativo · Tenda



**692E-140**

35 x 43 x 11 cm

**Kids cushion · Triangle**  
Cojin infantil · Triángulo  
Coussin enfant · Triangle  
Kinder-Kissen · Dreieck  
Cuscino decorativo · Triangolo

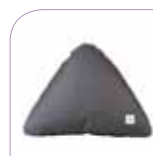

**692L-140**  
Grey | Gris  
Grise | Grau | Grigio

**690E-140**

35 x 35 x 15 cm

**Square cushion with removable cover**  
Cojin infantil cuadrado desfundable  
Coussin carré déhoussable  
Quadratisches Kissen (abziehbar)  
Cuscino quadrato sfoderabile



**690L-140**  
Grey | Gris  
Grise | Grau | Grigio

**694-140**

18 x 12 cm

**Garland-pennants (2,50 m long)**  
Guiraldas-banderines infantiles (2,50 m largo)  
Guirlande-banderole (2,50 m longueur)  
Stoff-Girlande (2,50 m lang)  
Ghirlanda-bandierine (2,50 m. lunghezza)



**693-140**

☆ 34 x 34 x 10 cm ♥ 20 x 20 x 8 cm ☾ 26 x 20 x 8 cm

**Set 3 decorative cushions**  
Set 3 cojines infantiles decoración  
Set 3 coussins décoratifs  
Set 3 Dekokissen  
Set 3 cuscini da decorazione



**618-140**

21 x 30 x 20 cm

**Padded baby toiletries basket**  
Cesta colonias infantil acolchada  
Panier matelassé pour produits de soin  
Gefütterter Stoffkorb für Badeartikel  
Cestino portasaponi trapuntato



**619-140**

41 x 34 x 34 cm

**Padded fabric storage basket**  
Saco de juguetes textil acolchado  
Panier de rangement matelassé  
Gefütterter Korb für Spielwaren  
Sacco portagiocchi trapuntato



**631-140**

15 x 60 x 90 cm

**Top changer for Konver 70x140 and chest**  
Vestidor para Konver 70x140 y cómoda  
Matelas à langer pour Konver 70x140 et commode  
Wickelaufgabe für Konver 70x140 und Kommode  
Fasciatoio Konver 70x140 e cassetiera



**633-140\***

10 x 51 x 82 cm

**Bath changer cover without foam**  
Funda vestidor sin espuma para bañeras  
Housse supplémentaire sans mousse pour baignoires  
Bezug für Wickelaufgabe ohne Schaumstoff für Waschtisch  
Fodera fasciatoio (senza materassino) per bagnetti



**634-140**

8 x 46 x 65 cm

**Top changer for Konver 60x120**  
Vestidor para Konver 60x120  
Matelas à langer pour Konver 60x120  
Wickelaufgabe für Konver 60x120  
Fasciatoio Konver 60x120



**698-140**

8 x 29 x 26 cm 8 x 42 x 26 cm

**Sleep positioner with removable cover**  
Cojin Antivelcro bebé desfundable  
Cale-bébé déhoussable  
Seitenschläferkissen (abziehbar)  
Riduttore dormisicuro sfoderabile



\* Inside foam ref. R-VE1 not included | Espuma interior Ref. R-VE1, no incluida  
Mousse intérieure Réf. R-VE1 pas incluse | Wickelaufgabe Ref. R-VE1 nicht inklusive | Materassino Rif. R-VE1, non incluso

# ARROW 140



**606-140** 90 x 140 cm  
**626-140** 105 x 165 cm  
**636-140** 150 x 220 cm

**Duvet cover (with duvet)**  
**Nórdico (con relleno)**  
 Housse et couette  
*Bettbezug (mit Decke)*  
 Piumino nordico (con imbottitura)



**606F-140** 90 x 140 cm  
**626F-140** 105 x 165 cm  
**636F-140** 150 x 220 cm

**Duvet cover (without duvet)**  
**Funda nórdica (sin relleno)**  
 Housse pour couette  
*Bettbezug (ohne Decke)*  
 Sacco nordico (senza imbottitura)

**670-140** 67 x 94 x 65 cm  
**Crib (colour 77 white matte)**  
**Minicuna (color 77 blanco mate)**  
 Berceau (couleur 77 blanc mat)  
*Stubenwagen (Farbe 77 Weiss matt)*  
 Culla (colore 77 bianco opaco)



**607-140** 180 x 44 cm  
**627-140** 210 x 44 cm

**Bumper Protector**  
 Tour de lit  
*Nestchen*  
 Paracolpi



**696-140** 15 x 55 x 50 cm  
**Nursing pillow with removable cover (cover + pad)**  
**Cojín de lactancia desenfundable (funda + relleno)**  
 Coussin d'allaitement déhoussable (housse + gamissage)  
*Stillkissen - abziehbar (Bezug + Füllung)*  
 Cuscino allattamento sfoderabile (fodera + imbottitura)



**647-140** 115 x 115 cm  
**Carpet for tepee tent**  
**Alfombra para Tipi infantil**  
 Tapis pour tipi  
*Teppich für Tipi- Kinderzelt*  
 Tappeto per tenda indiana



**612-140** 110 x 150 cm  
**632-140** 135 x 175 cm

**Cot sheets set - 3 pieces (100% Cotton)**  
**Sábanas cuna - 3 piezas (100% Algodón)**  
 Parure de lit - 3 pièces (100% Coton)  
*Bettwäsche - 3 tlg. (100% Baumwolle)*  
 Lenzuola lettino - 3 pezzi (100% Cotone)

**616-140** 95 x 122 cm

**Crib sheets set - 3 pieces (100% Cotton)**  
**Sábanas minicuna - 3 piezas (100% Algodón)**  
 Parure de berceau - 3 pièces (100% Coton)  
*Bettwäsche für Wiege 3-tlg. (100% Baumwolle)*  
 Lenzuola culla - 3 pezzi (100% Cotone)



Set  
3  
pieces

**697C-140** 15 x 114 x 58 cm  
**Large pregnancy pillow (cover + pad)**  
**Cojín de maternidad (funda + relleno)**  
 Coussin de maternité (housse + gamissage)  
*Schwangerschaftskissen (Bezug + Füllung)*  
 Cuscino premaman grande (fodera + imbottitura)



**646-140** 132 x 115 x 115 cm  
**Kids tepee tent**  
**Tipi infantil**  
 Tipi enfant  
*Tipi- Kinderzelt*  
 Tenda indiana



**688L-900**

36 x 46 x 11 cm

**Kids cushion · Ship**  
**Cojín infantil · Barco**  
 Coussin enfant · Bateau  
*Kinder-Kissen · Schiff*  
 Cuscino decorativo · Barchetta

**688L-151**

36 x 46 x 11 cm

**Kids cushion · Ship**  
**Cojín infantil · Barco**  
 Coussin enfant · Bateau  
*Kinder-Kissen · Schiff*  
 Cuscino decorativo · Barchetta

**692L-900**

35 x 43 x 11 cm

**Kids cushion · Triangle**  
**Cojín infantil · Triángulo**  
 Coussin enfant · Triangle  
*Kinder-Kissen · Dreieck*  
 Cuscino decorativo · Triangolo

**692L-901**

35 x 43 x 11 cm

**Kids cushion · Triangle**  
**Cojín infantil · Triángulo**  
 Coussin enfant · Triangle  
*Kinder-Kissen · Dreieck*  
 Cuscino decorativo · Triangolo

**694-151**

▼ 18 x 12 cm

**Garland-pennants (2,50 m long)**  
**Guirnalda-banderines infantiles (2,50 m largo)**  
 Guirlande-banderole (2,50 m longueur)  
*Stoff-Girlande (2,50 m lang)*  
 Ghirlanda-bandierine (2,50 m. lunghezza)

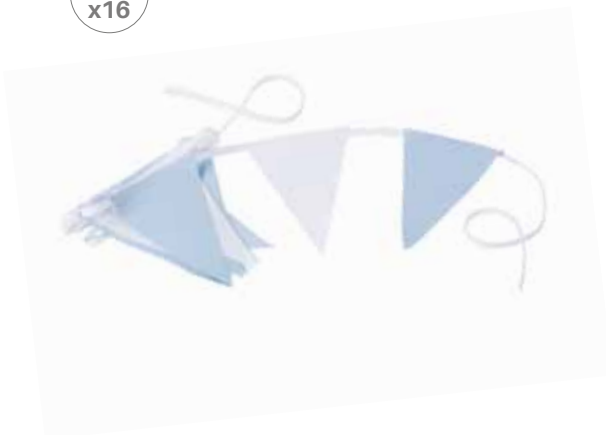
**693-151**

☆ 34 x 34 x 10 cm ♥ 20 x 20 x 8 cm ☾ 26 x 20 x 8 cm

**Set 3 decorative cushions**  
**Set 3 cojines infantiles decoración**  
 Set 3 coussins décoratifs  
*Set 3 Dekokissen*  
 Set 3 cuscini da decorazione

**618-151**

21 x 30 x 20 cm

**Padded baby toiletries basket**  
**Cesta colonias infantil acolchada**  
 Panier matelassé pour produits de soin  
*Gefütterter Stoffkorb für Badeartikel*  
 Cestino portasaponi trapuntato

**690A-151**

35 x 35 x 15 cm

**Square cushion with removable cover**  
**Cojín infantil cuadrado desfundable**  
 Coussin carré déhoussable  
*Quadratisches Kissen (abziehbar)*  
 Cuscino quadrato sfoderabile

**631-151**

15 x 60 x 90 cm

**Top changer for Konver 70x140 and chest**  
**Vestidor para Konver 70x140 y cómoda**  
 Matelas à langer pour Konver 70x140 et commode  
*Wickelaufgabe für Konver 70x140 und Kommode*  
 Fasciatoio Konver 70x140 e cassetiera

**633-151\***

10 x 51 x 82 cm

**Bath changer cover without foam**  
**Funda vestidor sin espuma para bañeras**  
 Housse supplémentaire sans mousse pour baignoires  
*Bezug für Wickelaufgabe ohne Schaumstoff für Waschtisch*  
 Fodera fasciatoio (senza materassino) per bagnetti

**634-151**

8 x 46 x 65 cm

**Top changer for Konver 60x120**  
**Vestidor para Konver 60x120**  
 Matelas à langer pour Konver 60x120  
*Wickelaufgabe für Konver 60x120*  
 Fasciatoio Konver 60x120

**619-151**

41 x 34 x 34 cm

**Padded fabric storage basket**  
**Saco de juguetes textil acolchado**  
 Panier de rangement matelassé  
*Gefütterter Korb für Spielwaren*  
 Sacco portagiocchi trapuntato



\* Inside foam ref. R-VE1 not included | Espuma interior Ref. R-VE1, no incluida  
 Mousse intérieure Réf. R-VE1 pas incluse | Wickelaufgabe Ref. R-VE1 nicht inklusive | Materassino Rif. R-VE1, non incluso

# NAVIO 151



60x120

**606-151**

90 x 140 cm

**Duvet cover (with duvet)**  
**Nórdico (con relleno)**  
 Housse et couette  
*Bettbezug (mit Decke)*  
 Plumino nordico (con imbottitura)

70x140

**626-151**

105 x 165 cm



60x120

**606F-151**

90 x 140 cm

**Duvet cover (without duvet)**  
**Funda nórdica (sin relleno)**  
 Housse pour couette  
*Bettbezug (ohne Decke)*  
 Sacco nordico (senza imbottitura)

70x140

**626F-151**

105 x 165 cm

60x120

**607-151**

180 x 44 cm

**Bumper Protector**  
 Tour de lit  
*Nestchen*  
 Paracolpi



70x140

**627-151**

210 x 44 cm



60x120

**612-151**

110 x 150 cm

**Cot sheets set - 3 pieces (100% Cotton)**  
**Sábanas cuna - 3 piezas (100% Algodón)**  
 Parure de lit - 3 pièces (100% Coton)  
*Bettwäsche - 3 tlg. (100% Baumwolle)*  
 Lenzuola lettino - 3 pezzi (100% Cotone)

70x140

**632-151**

135 x 175 cm

**616-151**

95 x 122 cm

**Crib sheets set - 3 pieces (100% Cotton)**  
**Sábanas minicuna - 3 piezas (100% Algodón)**  
 Parure de berceau - 3 pièces (100% Coton)  
*Bettwäsche für Wiege 3-tlg. (100% Baumwolle)*  
 Lenzuola culla - 3 pezzi (100% Cotone)



**670-151**

67 x 94 x 65 cm

**Crib (colour 77 white matte)**  
**Minicuna (color 77 blanco mate)**  
 Berceau (couleur 77 blanc mat)  
*Stubenwagen (Farbe 77 Weiss matt)*  
 Culla (colore 77 bianco opaco)



**697C-151**

15 x 114 x 58 cm

**Large pregnancy pillow (cover + pad)**  
**Cojin de maternidad (funda + relleno)**  
 Coussin de maternité (housse + gamissage)  
*Schwangerschaftskissen (Bezug + Füllung)*  
 Cuscino premaman grande (fodera + imbottitura)



**696-151**

15 x 55 x 50 cm

**Nursing pillow with removable cover (cover + pad)**  
**Cojin de lactancia desenfundable (funda + relleno)**  
 Coussin d'allaitement déhoussable (housse + gamissage)  
*Stillkissen - abziehbar (Bezug + Füllung)*  
 Cuscino allattamento sfoderabile (fodera + imbottitura)



**698-151**

8 x 29 x 26 cm

8 x 42 x 26 cm

**Sleep positioner with removable cover**  
**Cojin Antivuelco bebé desenfundable**  
 Cale-bébé déhoussable  
*Seitenschläferkissen (abziehbar)*  
 Riduttore dormisicuro sfoderabile



**689-902**

36 x 43 x 12 cm

**Kids cushion · Mountains**  
Cojin infantil · Montañas  
Coussin enfant · Montagnes  
Kinder-Kissen · Berge  
Cuscino decorativo · Montagna



**692L-900**

35 x 43 x 11 cm

**Kids cushion · Triangle**  
Cojin infantil · Triángulo  
Coussin enfant · Triangle  
Kinder-Kissen · Dreieck  
Cuscino decorativo · Triangolo



**692A-152**

35 x 43 x 11 cm

**Kids cushion · Triangle**  
Cojin infantil · Triángulo  
Coussin enfant · Triangle  
Kinder-Kissen · Dreieck  
Cuscino decorativo · Triangolo



**692L-902**

35 x 43 x 11 cm

**Kids cushion · Triangle**  
Cojin infantil · Triángulo  
Coussin enfant · Triangle  
Kinder-Kissen · Dreieck  
Cuscino decorativo · Triangolo



**694-152**

▼ 18 x 12 cm

**Garland-pennants (2,50 m long)**  
Guirnalda-banderines infantiles (2,50 m largo)  
Guirlande-banderole (2,50 m longueur)  
Stoff-Girlande (2,50 m lang)  
Ghirlanda-bandierine (2,50 m. lunghezza)

▼  
x16



**693-152**

☆ 34 x 34 x 10 cm    ♥ 20 x 20 x 8 cm    ☾ 26 x 20 x 8 cm

**Set 3 decorative cushions**  
Set 3 cojines infantiles decoración  
Set 3 coussins décoratifs  
Set 3 Dekokissen  
Set 3 cuscini da decorazione

Set  
3  
pieces



**618-152**

21 x 30 x 20 cm

**Padded baby toiletries basket**  
Cesta colonias infantil acolchada  
Panier matelassé pour produits de soin  
Gefütterter Stoffkorb für Badeartikel  
Cestino portasaponi trapuntato



**690A-152**

35 x 35 x 15 cm

**Square cushion with removable cover**  
Cojin infantil cuadrado desfundable  
Coussin carré déhoussable  
Quadratisches Kissen (abziehbar)  
Cuscino quadrato sfoderabile

▼



**631-152**

15 x 60 x 90 cm

**Top changer for Konver 70x140 and chest**  
Vestidor para Konver 70x140 y cómoda  
Matelas à langer pour Konver 70x140 et commode  
Wickelaufgabe für Konver 70x140 und Kommode  
Fasciatoio Konver 70x140 e cassettiera

▼  
VELCRO



**633-152\***

10 x 51 x 82 cm

**Bath changer cover without foam**  
Funda vestidor sin espuma para bañeras  
Housse supplémentaire sans mousse pour baignoires  
Bezug für Wickelaufgabe ohne Schaumstoff für Waschtisch  
Fodera fasciatoio (senza materassino) per bagnetti

▼



**634-152**

8 x 46 x 65 cm

**Top changer for Konver 60x120**  
Vestidor para Konver 60x120  
Matelas à langer pour Konver 60x120  
Wickelaufgabe für Konver 60x120  
Fasciatoio Konver 60x120

▼



**619-152**

41 x 34 x 34 cm

**Padded fabric storage basket**  
Saco de juguetes textil acolchado  
Panier de rangement matelassé  
Gefütterter Korb für Spielwaren  
Sacco portagiocchi trapuntato



\* Inside foam ref. R-VE1 not included | Espuma interior Ref. R-VE1, no incluida  
Mousse intérieure Réf. R-VE1 pas incluse | Wickelaufgabe Ref. R-VE1 nicht inklusive | Materassino Rif. R-VE1, non incluso

# AROSA 152



60x120

**606-152**

90 x 140 cm

**Duvet cover (with duvet)**  
**Nórdico (con relleno)**  
 Housse et couette  
*Bettbezug (mit Decke)*  
 Piumino nordico (con imbottitura)

70x140

**626-152**

105 x 165 cm



60x120

**606F-152**

90 x 140 cm

**Duvet cover (without duvet)**  
**Funda nórdica (sin relleno)**  
 Housse pour couette  
*Bettbezug (ohne Decke)*  
 Sacco nordico (senza imbottitura)

70x140

**626F-152**

105 x 165 cm

60x120

**607-152**

180 x 44 cm

**Bumper Protector**  
 Tour de lit  
*Nestchen*  
 Paracolpi



70x140

**627-152**

210 x 44 cm



60x120

**612-152**

110 x 150 cm

**Cot sheets set - 3 pieces (100% Cotton)**  
**Sábanas cuna - 3 piezas (100% Algodón)**  
 Parure de lit - 3 pièces (100% Coton)  
*Bettwäsche - 3 tlg. (100% Baumwolle)*  
 Lenzuola lettino - 3 pezzi (100% Cotone)

70x140

**632-152**

135 x 175 cm

**616-152**

95 x 122 cm

**Crib sheets set - 3 pieces (100% Cotton)**  
**Sábanas minicuna - 3 piezas (100% Algodón)**  
 Parure de berceau - 3 pièces (100% Coton)  
*Bettwäsche für Wiege 3-tlg. (100% Baumwolle)*  
 Lenzuola culla - 3 pezzi (100% Cotone)



Set  
3  
pieces

**670-152**

67 x 94 x 65 cm

**Crib (colour 77 white matte)**  
**Minicuna (color 77 blanco mate)**  
 Berceau (couleur 77 blanc mat)  
*Stubenwagen (Farbe 77 Weiss matt)*  
 Culla (colore 77 bianco opaco)



**697C-152**

15 x 114 x 58 cm

**Large pregnancy pillow (cover + pad)**  
**Cojin de maternidad (funda + relleno)**  
 Coussin de maternité (housse + gamissage)  
*Schwangerschaftskissen (Bezug + Füllung)*  
 Cuscino premaman grande (fodera + imbottitura)



**696-152**

15 x 55 x 50 cm

**Nursing pillow with removable cover (cover + pad)**  
**Cojin de lactancia desenfundable (funda + relleno)**  
 Coussin d'allaitement déhoussable (housse + gamissage)  
*Stillkissen · abziehbar (Bezug + Füllung)*  
 Cuscino allattamento sfoderabile (fodera + imbottitura)



**698-152**

8 x 29 x 26 cm

8 x 42 x 26 cm

**Sleep positioner with removable cover**  
**Cojin Antivuelco bebé desenfundable**  
 Cale-bébé déhoussable  
*Seitenschläferkissen (abziehbar)*  
 Riduttore dormisicuro sfoderabile



**689-153**

36 x 43 x 12 cm

**Kids cushion · Mountains**  
Cojín infantil · Montañas  
Coussin enfant · Montagnes  
Kinder-Kissen · Berge  
Cuscino decorativo · Montagna



**691-153**

36 x 32 x 10 cm

**Kids cushion · Teepee tent**  
Cojín infantil · Tipi  
Coussin enfant · Tipi  
Kinder-Kissen · Tipi  
Cuscino decorativo · Tenda



**692L-900**

35 x 43 x 11 cm

**Kids cushion · Triangle**  
Cojín infantil · Triángulo  
Coussin enfant · Triangle  
Kinder-Kissen · Dreieck  
Cuscino decorativo · Triangolo



**692G-153**

35 x 43 x 11 cm

**Kids cushion · Triangle**  
Cojín infantil · Triángulo  
Coussin enfant · Triangle  
Kinder-Kissen · Dreieck  
Cuscino decorativo · Triangolo



**694-153**

▼ 18 x 12 cm

**Garland-pennants (2,50 m long)**  
Guirnalda-banderines infantiles (2,50 m largo)  
Guirlande-banderole (2,50 m longueur)  
Stoff-Girlande (2,50 m lang)  
Ghirlanda-bandierine (2,50 m. lunghezza)

▼  
x16



**693-153**

☆ 34 x 34 x 10 cm ♥ 20 x 20 x 8 cm ☾ 26 x 20 x 8 cm

**Set 3 decorative cushions**  
Set 3 cojines infantiles decoración  
Set 3 coussins décoratifs  
Set 3 Dekokissen  
Set 3 cuscini da decorazione

Set  
3  
pieces



**618-153**

21 x 30 x 20 cm

**Padded baby toiletries basket**  
Cesta colonias infantil acolchada  
Panier matelassé pour produits de soin  
Gefütterter Stoffkorb für Badeartikel  
Cestino portasaponi trapuntato



**690G-153**

35 x 35 x 15 cm

**Square cushion with removable cover**  
Cojín infantil cuadrado desfundable  
Coussin carré déhoussable  
Quadratisches Kissen (abziehbar)  
Cuscino quadrato sfoderabile

▼



**631-153**

15 x 60 x 90 cm

**Top changer for Konver 70x140 and chest**  
Vestidor para Konver 70x140 y cómoda  
Matelas à langer pour Konver 70x140 et commode  
Wickelaufgabe für Konver 70x140 und Kommode  
Fasciatoio Konver 70x140 e cassetiera

▼  
VELCRO



**633-153\***

10 x 51 x 82 cm

**Bath changer cover without foam**  
Funda vestidor sin espuma para bañeras  
Housse supplémentaire sans mousse pour baignoires  
Bezug für Wickelaufgabe ohne Schaumstoff für Waschtisch  
Fodera fasciatoio (senza materassino) per bagnetti

▼



**634-153**

8 x 46 x 65 cm

**Top changer for Konver 60x120**  
Vestidor para Konver 60x120  
Matelas à langer pour Konver 60x120  
Wickelaufgabe für Konver 60x120  
Fasciatoio Konver 60x120

▼



**619-153**

41 x 34 x 34 cm

**Padded fabric storage basket**  
Saco de juguetes textil acolchado  
Panier de rangement matelassé  
Gefütterter Korb für Spielwaren  
Sacco portagiocchi trapuntato



\* Inside foam ref. R-VE1 not included | Espuma interior Ref. R-VE1, no incluida  
Mousse intérieure Réf. R-VE1 pas incluse | Wickelaufgabe Ref. R-VE1 nicht inklusive | Materassino Rif. R-VE1, non incluso



# ARENA 153



60x120

**606-153**

90 x 140 cm

70x140

**626-153**

105 x 165 cm

90x200

**636-153**

150 x 220 cm

**Duvet cover (with duvet)**  
**Nórdico (con relleno)**  
 Housse et couette  
*Bettbezug (mit Decke)*  
 Piumino nordico (con imbottitura)

60x120

**606F-153**

90 x 140 cm

70x140

**626F-153**

105 x 165 cm

90x200

**636F-153**

150 x 220 cm

**Duvet cover (without duvet)**  
**Funda nórdica (sin relleno)**  
 Housse pour couette  
*Bettbezug (ohne Decke)*  
 Sacco nordico (senza imbottitura)



60x120

**607-153**

180 x 44 cm

70x140

**627-153**

210 x 44 cm

**Bumper Protector**  
 Tour de lit  
*Nestchen*  
 Paracolpi



**670-153**

67 x 94 x 65 cm

**Crib (colour 77 white matte)**  
**Minicuna (color 77 blanco mate)**  
 Berceau (couleur 77 blanc mat)  
*Stubenwagen (Farbe 77 Weiss matt)*  
 Culla (colore 77 bianco opaco)



**647-153**

115 x 115 cm

**Carpet for tepee tent**  
**Alfombra para Tipi infantil**  
 Tapis pour tipi  
*Teppich für Tipi- Kinderzelt*  
 Tappeto per tenda indiana



60x120

**612-153**

110 x 150 cm

70x140

**632-153**

135 x 175 cm

**Cot sheets set - 3 pieces (100% Cotton)**  
**Sábanas cuna - 3 piezas (100% Algodón)**  
 Parure de lit - 3 pièces (100% Coton)  
*Bettwäsche - 3 tlg. (100% Baumwolle)*  
 Lenzuola lettino - 3 pezzi (100% Cotone)



**698-153**

8 x 29 x 26 cm  
 8 x 42 x 26 cm

**Sleep positioner with removable cover**  
**Cojín Antivelco bebé desenfundable**  
 Cale-bébé déhoussable  
*Seitenschläferkissen (abziehbar)*  
 Riduttore dormisicuro sfoderabile



**646-153**

132 x 115 x 115 cm

**Kids tepee tent**  
**Tipi infantil**  
 Tipi enfant  
*Tipi- Kinderzelt*  
 Tenda indiana



Set  
 3  
 pieces

**689-178**

36 x 43 x 12 cm

**Kids cushion · Mountains**  
Cojín infantil · Montañas  
Coussin enfant · Montagnes  
Kinder-Kissen · Berge  
Cuscino decorativo · Montagna



**691-178**

36 x 32 x 10 cm

**Kids cushion · Teepee tent**  
Cojín infantil · Tipi  
Coussin enfant · Tipi  
Kinder-Kissen · Tipi  
Cuscino decorativo · Tenda



**692L-900**

35 x 43 x 11 cm

**Kids cushion · Triangle**  
Cojín infantil · Triángulo  
Coussin enfant · Triangle  
Kinder-Kissen · Dreieck  
Cuscino decorativo · Triangolo



**692G-178**

35 x 43 x 11 cm

**Kids cushion · Triangle**  
Cojín infantil · Triángulo  
Coussin enfant · Triangle  
Kinder-Kissen · Dreieck  
Cuscino decorativo · Triangolo



**694-178**

▼ 18 x 12 cm

**Garland-pennants (2,50 m long)**  
Guirnalda-banderines infantiles (2,50 m largo)  
Guirlande-banderole (2,50 m longueur)  
Stoff-Girlande (2,50 m lang)  
Ghirlanda-bandierine (2,50 m. lunghezza)

▼  
x16



**693-178**

☆ 34 x 34 x 10 cm    ♥ 20 x 20 x 8 cm    ☾ 26 x 20 x 8 cm

**Set 3 decorative cushions**  
Set 3 cojines infantiles decoración  
Set 3 coussins décoratifs  
Set 3 Dekokissen  
Set 3 cuscini da decorazione

Set  
3  
pieces



**618-178**

21 x 30 x 20 cm

**Padded baby toiletries basket**  
Cesta colonias infantil acolchada  
Panier matelassé pour produits de soin  
Gefütterter Stoffkorb für Badeartikel  
Cestino portasaponi trapuntato



**690G-178**

35 x 35 x 15 cm

**Square cushion with removable cover**  
Cojín infantil cuadrado desfundable  
Coussin carré déhoussable  
Quadratisches Kissen (abziehbar)  
Cuscino quadrato sfoderabile

▼



**631-178**

15 x 60 x 90 cm

**Top changer for Konver 70x140 and chest**  
Vestidor para Konver 70x140 y cómoda  
Matelas à langer pour Konver 70x140 et commode  
Wickelaufgabe für Konver 70x140 und Kommode  
Fasciatoio Konver 70x140 e cassetiera

▼  
VELCRO



**633-178\***

10 x 51 x 82 cm

**Bath changer cover without foam**  
Funda vestidor sin espuma para bañeras  
Housse supplémentaire sans mousse pour baignoires  
Bezug für Wickelaufgabe ohne Schaumstoff für Waschtisch  
Fodera fasciatoio (senza materassino) per bagnetti

▼



**634-178**

8 x 46 x 65 cm

**Top changer for Konver 60x120**  
Vestidor para Konver 60x120  
Matelas à langer pour Konver 60x120  
Wickelaufgabe für Konver 60x120  
Fasciatoio Konver 60x120

▼



**619-178**

41 x 34 x 34 cm

**Padded fabric storage basket**  
Saco de juguetes textil acolchado  
Panier de rangement matelassé  
Gefütterter Korb für Spielwaren  
Sacco portagiocchi trapuntato



\* Inside foam ref. R-VE1 not included | Espuma interior Ref. R-VE1, no incluida  
Mousse intérieure Réf. R-VE1 pas incluse | Wickelaufgabe Ref. R-VE1 nicht inklusive | Materassino Rif. R-VE1, non incluso

# CAREZZA 178



**606-178** 90 x 140 cm  
**626-178** 105 x 165 cm  
**636-178** 150 x 220 cm

**Duvet cover (with duvet)**  
**Nórdico (con relleno)**  
 Housse et couette  
*Bettbezug (mit Decke)*  
 Piumino nordico (con imbottitura)

**606F-178** 90 x 140 cm  
**626F-178** 105 x 165 cm  
**636F-178** 150 x 220 cm

**Duvet cover (without duvet)**  
**Funda nórdica (sin relleno)**  
 Housse pour couette  
*Bettbezug (ohne Decke)*  
 Sacco nordico (senza imbottitura)



**Co-sleeping crib & textile set (+ info pages 4-9)**  
**Minicuna de colecho y Kit textil (+ info págs. 4-9)**  
 Berceau cododo + kit textile (+ info pages 4-9)  
*Beistellbett + Textil-Set (+ Info auf Seiten 4-9)*  
 Culla fianco letto + pack tessile (+ info pages. 4-9)

**607-178** 180 x 44 cm  
**627-178** 210 x 44 cm

**Bumper Protector**  
 Tour de lit  
*Nestchen*  
 Paracolpi



**670-178** 67 x 94 x 65 cm  
**Crib (colour 77 white matte)**  
**Minicuna (color 77 blanco mate)**  
 Berceau (couleur 77 blanc mat)  
*Stubenwagen (Farbe 77 Weiss matt)*  
 Culla (colore 77 bianco opaco)



**647-178** 115 x 115 cm  
**Carpet for tepee tent**  
**Alfombra para Tipi infantil**  
 Tapis pour tipi  
*Teppich für Tipi- Kinderzelt*  
 Tappeto per tenda indiana



**612-178** 110 x 150 cm  
**632-178** 135 x 175 cm

**Cot sheets set - 3 pieces (100% Cotton)**  
**Sábanas cuna - 3 piezas (100% Algodón)**  
 Parure de lit - 3 pièces (100% Coton)  
*Bettwäsche - 3 tlg. (100% Baumwolle)*  
 Lenzuola lettino - 3 pezzi (100% Cotone)

**616-178** 95 x 122 cm

**Crib sheets set - 3 pieces (100% Cotton)**  
**Sábanas minicuna - 3 piezas (100% Algodón)**  
 Parure de berceau - 3 pièces (100% Coton)  
*Bettwäsche für Wiege 3-tlg. (100% Baumwolle)*  
 Lenzuola culla - 3 pezzi (100% Cotone)



**698-178**  
 8 x 29 x 26 cm  
 8 x 42 x 26 cm  
**Sleep positioner with removable cover**  
**Cojín Antivelco bebé desenfundable**  
 Cale-bébé déhoussable  
*Seitenschlãferkissen (abziehbar)*  
 Riduttore dormisicuro sfoderabile



**646-178** 132 x 115 x 115 cm  
**Kids tepee tent**  
**Tipi infantil**  
 Tipi enfant  
*Tipi- Kinderzelt*  
 Tenda indiana



Set  
3  
pieces

**690E-179**

35 x 35 x 15 cm

**Square cushion with removable cover**  
**Cojín infantil cuadrado desenfundable**  
 Coussin carré déhoussable  
 Quadratisches Kissen (abziehbar)  
 Cuscino quadrato sfoderabile

**690L-179**

35 x 35 x 15 cm

**Square cushion with removable cover**  
**Cojín infantil cuadrado desenfundable**  
 Coussin carré déhoussable  
 Quadratisches Kissen (abziehbar)  
 Cuscino quadrato sfoderabile

**618-179**

21 x 30 x 20 cm

**Padded baby toiletries basket**  
**Cesta colonias infantil acolchada**  
 Panier matelassé pour produits de soin  
 Gefütterter Stoffkorb für Badeartikel  
 Cestino portasaponi trapuntato

**619-179**

41 x 34 x 34 cm

**Padded fabric storage basket**  
**Saco de juguetes textil acolchado**  
 Panier de rangement matelassé  
 Gefütterter Korb für Spielwaren  
 Sacco portagiochi trapuntato

**694-179**

▼ 18 x 12 cm

**Garland-pennants (2,50 m long)**  
**Guiraldas-banderines infantiles (2,50 m largo)**  
 Guirlande-banderole (2,50 m longueur)  
 Stoff-Girlande (2,50 m lang)  
 Ghirlanda-bandierine (2,50 m. lunghezza)

**693-179**

☆ 34 x 34 x 10 cm ♥ 20 x 20 x 8 cm ☾ 26 x 20 x 8 cm

**Set 3 decorative cushions**  
**Set 3 cojines infantiles decoración**  
 Set 3 coussins décoratifs  
 Set 3 Dekokissen  
 Set 3 cuscini da decorazione

**696-179**

15 x 55 x 50 cm

**Nursing pillow with removable cover (cover + pad)**  
**Cojín de lactancia desenfundable (funda + relleno)**  
 Coussin d'allaitement déhoussable (housse + gamissage)  
 Stillkissen · abziehbar (Bezug + Füllung)  
 Cuscino allattamento sfoderabile (fodera + imbottitura)

**697C-179**

15 x 114 x 58 cm

**Large pregnancy pillow (cover + pad)**  
**Cojín de maternidad (funda + relleno)**  
 Coussin de maternité (housse + gamissage)  
 Schwangerschaftskissen (Bezug + Füllung)  
 Cuscino premaman grande (fodera + imbottitura)

**631-179**

15 x 60 x 90 cm

**Top changer for Konver 70x140 and chest**  
**Vestidor para Konver 70x140 y cómoda**  
 Matelas à langer pour Konver 70x140 et commode  
 Wickelauflage für Konver 70x140 und Kommode  
 Fasciatoio Konver 70x140 e cassetiera

**633-179\***

10 x 51 x 82 cm

**Bath changer cover without foam**  
**Funda vestidor sin espuma para bañeras**  
 Housse supplémentaire sans mousse pour baignoires  
 Bezug für Wickelauflage ohne Schaumstoff für Waschtisch  
 Fodera fasciatoio (senza materassino) per bagnetti

**634-179**

8 x 46 x 65 cm

**Top changer for Konver 60x120**  
**Vestidor para Konver 60x120**  
 Matelas à langer pour Konver 60x120  
 Wickelauflage für Konver 60x120  
 Fasciatoio Konver 60x120

**698-179**

┌ 8 x 29 x 26 cm ┐ 8 x 42 x 26 cm

**Sleep positioner with removable cover**  
**Cojín Antivelco bebé desenfundable**  
 Cale-bébé déhoussable  
 Seitenschläferkissen (abziehbar)  
 Riduttore dormisicuro sfoderabile



\* Inside foam ref. R-VE1 not included | Espuma interior Ref. R-VE1, no incluida  
 Mousse intérieure Réf. R-VE1 pas incluse | Wickelauflage Ref. R-VE1 nicht inklusive | Materassino Rif. R-VE1, non incluso

# ETNIK 179



60x120

**606-179**

90 x 140 cm

**Duvet cover (with duvet)**  
Nórdico (con relleno)  
Housse et couette  
Bettbezug (mit Decke)  
Piumino nordico (con imbottitura)

70x140

**626-179**

105 x 165 cm

90x200

**636-179**

150 x 220 cm

60x120

**606F-179**

90 x 140 cm

**Duvet cover (without duvet)**  
Funda nórdica (sin relleno)  
Housse pour couette  
Bettbezug (ohne Decke)  
Sacco nordico (senza imbottitura)

70x140

**626F-179**

105 x 165 cm

90x200

**636F-179**

150 x 220 cm



**636-179**  
**636F-179**

60x120

**607-179**

180 x 44 cm

**Bumper Protector**  
Tour de lit  
Nestchen  
Paracolpi

70x140

**627-179**

210 x 44 cm



**670-179**

67 x 94 x 65 cm

**Crib (colour 77 white matte)**  
Minicuna (color 77 blanco mate)  
Berceau (couleur 77 blanc mat)  
Stubenwagen (Farbe 77 Weiss matt)  
Culla (colore 77 bianco opaco)



60x120

**612-179**

110 x 150 cm

**Cot sheets set - 3 pieces (100% Cotton)**  
Sábanas cuna - 3 piezas (100% Algodón)  
Parure de lit - 3 pièces (100% Coton)  
Bettwäsche - 3 tlg. (100% Baumwolle)  
Lenzuola lettino - 3 pezzi (100% Cotone)

70x140

**632-179**

135 x 175 cm

**616-179**

95 x 122 cm

**Crib sheets set - 3 pieces (100% Cotton)**  
Sábanas minicuna - 3 piezas (100% Algodón)  
Parure de berceau - 3 pièces (100% Coton)  
Bettwäsche für Wiege 3-tlg. (100% Baumwolle)  
Lenzuola culla - 3 pezzi (100% Cotone)



**647-179**

115 x 115 cm

**Carpet for teepee tent**  
Alfombra para Tipi infantil  
Tapis pour tipi  
Teppich für Tipi- Kinderzelt  
Tappeto per tenda indiana

**646-179**

132 x 115 x 115 cm

**Kids teepee tent**  
Tipi infantil  
Tipi enfant  
Tipi- Kinderzelt  
Tenda indiana



Set  
3  
pieces

**690E-181**

35 x 35 x 15 cm

**Square cushion with removable cover**  
**Cojín infantil cuadrado desenfundable**  
 Coussin carré déhoussable  
 Quadratisches Kissen (abziehbar)  
 Cuscino quadrato sfoderabile

**690L-181**

35 x 35 x 15 cm

**Square cushion with removable cover**  
**Cojín infantil cuadrado desenfundable**  
 Coussin carré déhoussable  
 Quadratisches Kissen (abziehbar)  
 Cuscino quadrato sfoderabile

**618-181**

21 x 30 x 20 cm

**Padded baby toiletries basket**  
**Cesta colonias infantil acolchada**  
 Panier matelassé pour produits de soin  
 Gefütterter Stoffkorb für Badeartikel  
 Cestino portasaponi trapuntato

**619-181**

41 x 34 x 34 cm

**Padded fabric storage basket**  
**Saco de juguetes textil acolchado**  
 Panier de rangement matelassé  
 Gefütterter Korb für Spielwaren  
 Sacco portagiochi trapuntato

**694-181**

▼ 18 x 12 cm

**Garland-pennants (2,50 m long)**  
**Guiraldas-banderines infantiles (2,50 m largo)**  
 Guirlande-banderole (2,50 m longueur)  
 Stoff-Girlande (2,50 m lang)  
 Ghirlanda-bandierine (2,50 m. lunghezza)

**693-181**

☆ 34 x 34 x 10 cm ♥ 20 x 20 x 8 cm ☾ 26 x 20 x 8 cm

**Set 3 decorative cushions**  
**Set 3 cojines infantiles decoración**  
 Set 3 coussins décoratifs  
 Set 3 Dekokissen  
 Set 3 cuscini da decorazione

**696-181**

15 x 55 x 50 cm

**Nursing pillow with removable cover (cover + pad)**  
**Cojín de lactancia desenfundable (funda + relleno)**  
 Coussin d'allaitement déhoussable (housse + gamissage)  
 Stillkissen - abziehbar (Bezug + Füllung)  
 Cuscino allattamento sfoderabile (fodera + imbottitura)

**697C-181**

15 x 114 x 58 cm

**Large pregnancy pillow (cover + pad)**  
**Cojín de maternidad (funda + relleno)**  
 Coussin de maternité (housse + gamissage)  
 Schwangerschaftskissen (Bezug + Füllung)  
 Cuscino premaman grande (fodera + imbottitura)

**631-181**

15 x 60 x 90 cm

**Top changer for Konver 70x140 and chest**  
**Vestidor para Konver 70x140 y cómoda**  
 Matelas à langer pour Konver 70x140 et commode  
 Wickelauflage für Konver 70x140 und Kommode  
 Fasciatoio Konver 70x140 e cassetiera

**633-181\***

10 x 51 x 82 cm

**Bath changer cover without foam**  
**Funda vestidor sin espuma para bañeras**  
 Housse supplémentaire sans mousse pour baignoires  
 Bezug für Wickelauflage ohne Schaumstoff für Waschtisch  
 Fodera fasciatoio (senza materassino) per bagnetti

**634-181**

8 x 46 x 65 cm

**Top changer for Konver 60x120**  
**Vestidor para Konver 60x120**  
 Matelas à langer pour Konver 60x120  
 Wickelauflage für Konver 60x120  
 Fasciatoio Konver 60x120

**698-181**

□ 8 x 29 x 26 cm □ 8 x 42 x 26 cm

**Sleep positioner with removable cover**  
**Cojín Antivelco bebé desenfundable**  
 Cale-bébé déhoussable  
 Seitenschläferkissen (abziehbar)  
 Riduttore dormisicuro sfoderabile



\* Inside foam ref. R-VE1 not included | Espuma interior Ref. R-VE1, no incluida  
 Mousse intérieure Réf. R-VE1 pas incluse | Wickelauflage Ref. R-VE1 nicht inklusive | Materassino Rif. R-VE1, non incluso

# MARE 181



**606-181** 90 x 140 cm  
**626-181** 105 x 165 cm  
**636-181** 150 x 220 cm

**Duvet cover (with duvet)**  
**Nórdico (con relleno)**  
 Housse et couette  
*Bettbezug (mit Decke)*  
 Piumino nordico (con imbottitura)

**606F-181** 90 x 140 cm  
**626F-181** 105 x 165 cm  
**636F-181** 150 x 220 cm

**Duvet cover (without duvet)**  
**Funda nórdica (sin relleno)**  
 Housse pour couette  
*Bettbezug (ohne Decke)*  
 Sacco nordico (senza imbottitura)



**636-181**  
**636F-181**

**Co-sleeping crib & textile set (+ info pages 4-9)**  
**Minicuna de colecho y Kit textil (+ info págs. 4-9)**  
 Berceau cododo + kit textile (+ info pages 4-9)  
*Beistellbett + Textil-Set (+ Info auf Seiten 4-9)*  
 Culla fianco letto + pack tessile (+ info pages. 4-9)

**607-181** 180 x 44 cm  
**627-181** 210 x 44 cm

**Bumper Protector**  
 Tour de lit  
*Nestchen*  
 Paracolpi



**670-181**  
 67 x 94 x 65 cm

**Crib (colour 77 white matte)**  
**Minicuna (color 77 blanco mate)**  
 Berceau (couleur 77 blanc mat)  
*Stubenwagen (Farbe 77 Weiss matt)*  
 Culla (colore 77 bianco opaco)



**612-181** 110 x 150 cm  
**632-181** 135 x 175 cm

**Cot sheets set - 3 pieces (100% Cotton)**  
**Sábanas cuna - 3 piezas (100% Algodón)**  
 Parure de lit - 3 pièces (100% Coton)  
*Bettwäsche - 3 tlg. (100% Baumwolle)*  
 Lenzuola lettino - 3 pezzi (100% Cotone)

**616-181**  
 95 x 122 cm

**Crib sheets set - 3 pieces (100% Cotton)**  
**Sábanas minicuna - 3 piezas (100% Algodón)**  
 Parure de berceau - 3 pièces (100% Coton)  
*Bettwäsche für Wiege 3-tlg. (100% Baumwolle)*  
 Lenzuola culla - 3 pezzi (100% Cotone)



**647-181** 115 x 115 cm  
**Carpet for teepee tent**  
**Alfombra para Tipi infantil**  
 Tapis pour tipi  
*Teppich für Tipi- Kinderzelt*  
 Tappeto per tenda indiana

**646-181** 132 x 115 x 115 cm  
**Kids teepee tent**  
**Tipi infantil**  
 Tipi enfant  
*Tipi- Kinderzelt*  
 Tenda indiana



Set  
**3**  
 pieces

**690E-182**

35 x 35 x 15 cm

**Square cushion with removable cover**  
**Cojín infantil cuadrado desenfundable**  
 Coussin carré déhoussable  
 Quadratisches Kissen (abziehbar)  
 Cuscino quadrato sfoderabile

**690L-182**

35 x 35 x 15 cm

**Square cushion with removable cover**  
**Cojín infantil cuadrado desenfundable**  
 Coussin carré déhoussable  
 Quadratisches Kissen (abziehbar)  
 Cuscino quadrato sfoderabile

**618-182**

21 x 30 x 20 cm

**Padded baby toiletries basket**  
**Cesta colonias infantil acolchada**  
 Panier matelassé pour produits de soin  
 Gefütterter Stoffkorb für Badeartikel  
 Cestino portasaponi trapuntato

**619-182**

41 x 34 x 34 cm

**Padded fabric storage basket**  
**Saco de juguetes textil acolchado**  
 Panier de rangement matelassé  
 Gefütterter Korb für Spielwaren  
 Sacco portagiochi trapuntato

**694-182**

▼ 18 x 12 cm

**Garland-pennants (2,50 m long)**  
**Guirnalda-banderines infantiles (2,50 m largo)**  
 Guirlande-banderole (2,50 m longueur)  
 Stoff-Girlande (2,50 m lang)  
 Ghirlanda-bandierine (2,50 m. lunghezza)

**693-182**

☆ 34 x 34 x 10 cm ♥ 20 x 20 x 8 cm ☾ 26 x 20 x 8 cm

**Set 3 decorative cushions**  
**Set 3 cojines infantiles decoración**  
 Set 3 coussins décoratifs  
 Set 3 Dekokissen  
 Set 3 cuscini da decorazione

**696-182**

15 x 55 x 50 cm

**Nursing pillow with removable cover (cover + pad)**  
**Cojín de lactancia desenfundable (funda + relleno)**  
 Coussin d'allaitement déhoussable (housse + gamissage)  
 Stillkissen - abziehbar (Bezug + Füllung)  
 Cuscino allattamento sfoderabile (fodera + imbottitura)

**697C-182**

15 x 114 x 58 cm

**Large pregnancy pillow (cover + pad)**  
**Cojín de maternidad (funda + relleno)**  
 Coussin de maternité (housse + gamissage)  
 Schwangerschaftskissen (Bezug + Füllung)  
 Cuscino premaman grande (fodera + imbottitura)

**631-182**

15 x 60 x 90 cm

**Top changer for Konver 70x140 and chest**  
**Vestidor para Konver 70x140 y cómoda**  
 Matelas à langer pour Konver 70x140 et commode  
 Wickelauflage für Konver 70x140 und Kommode  
 Fasciatoio Konver 70x140 e cassetiera

**633-182\***

10 x 51 x 82 cm

**Bath changer cover without foam**  
**Funda vestidor sin espuma para bañeras**  
 Housse supplémentaire sans mousse pour baignoires  
 Bezug für Wickelauflage ohne Schaumstoff für Waschtisch  
 Fodera fasciatoio (senza materassino) per bagnetti

**634-182**

8 x 46 x 65 cm

**Top changer for Konver 60x120**  
**Vestidor para Konver 60x120**  
 Matelas à langer pour Konver 60x120  
 Wickelauflage für Konver 60x120  
 Fasciatoio Konver 60x120

**698-182**

□ 8 x 29 x 26 cm □ 8 x 42 x 26 cm

**Sleep positioner with removable cover**  
**Cojín Antivelco bebé desenfundable**  
 Cale-bébé déhoussable  
 Seitenschläferkissen (abziehbar)  
 Riduttore dormiscuro sfoderabile



\* Inside foam ref. R-VE1 not included | Espuma interior Ref. R-VE1, no incluida  
 Mousse intérieure Réf. R-VE1 pas incluse | Wickelauflage Ref. R-VE1 nicht inklusive | Materassino Rif. R-VE1, non incluso



# ROSE 182



60x120

**606-182**

90 x 140 cm

70x140

**626-182**

105 x 165 cm

90x200

**636-182**

150 x 220 cm

**Duvet cover (with duvet)**  
**Nórdico (con relleno)**  
 Housse et couette  
*Bettbezug (mit Decke)*  
 Piumino nordico (con imbottitura)

60x120

**606F-182**

90 x 140 cm

70x140

**626F-182**

105 x 165 cm

90x200

**636F-182**

150 x 220 cm

**Duvet cover (without duvet)**  
**Funda nórdica (sin relleno)**  
 Housse pour couette  
*Bettbezug (ohne Decke)*  
 Sacco nordico (senza imbottitura)



**636-182**  
**636F-182**

60x120

**607-182**

180 x 44 cm

70x140

**627-182**

210 x 44 cm

**Bumper Protector**  
 Tour de lit  
*Nestchen*  
 Paracolpi



**670-182**

67 x 94 x 65 cm

**Crib (colour 77 white matte)**  
**Minicuna (color 77 blanco mate)**  
 Berceau (couleur 77 blanc mat)  
*Stubenwagen (Farbe 77 Weiss matt)*  
 Culla (colore 77 bianco opaco)



60x120

**612-182**

110 x 150 cm

70x140

**632-182**

135 x 175 cm

**Cot sheets set - 3 pieces (100% Cotton)**  
**Sábanas cuna - 3 piezas (100% Algodón)**  
 Parure de lit - 3 pièces (100% Coton)  
*Bettwäsche - 3 tlg. (100% Baumwolle)*  
 Lenzuola lettino - 3 pezzi (100% Cotone)

**616-182**

95 x 122 cm

**Crib sheets set - 3 pieces (100% Cotton)**  
**Sábanas minicuna - 3 piezas (100% Algodón)**  
 Parure de berceau - 3 pièces (100% Coton)  
*Bettwäsche für Wiege 3-tlg. (100% Baumwolle)*  
 Lenzuola culla - 3 pezzi (100% Cotone)



**647-182**

115 x 115 cm

**Carpet for tepee tent**  
**Alfombra para Tipi infantil**  
 Tapis pour tipi  
*Teppich für Tipi- Kinderzelt*  
 Tappeto per tenda indiana



**646-182**

132 x 115 x 115 cm

**Kids tepee tent**  
**Tipi infantil**  
 Tipi enfant  
*Tipi- Kinderzelt*  
 Tenda indiana



Set  
**3**  
 pieces

# COLOURS

## FURNITURE | MOBILIARIO

MOBILIER | MÖBEL

MOBILI

Matte | Mate | Mate | Matt | Opaco

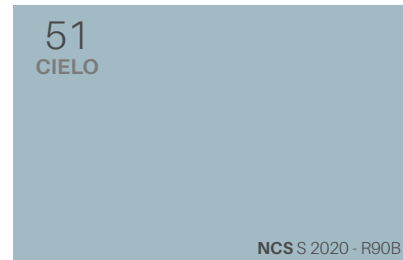

**51**  
CIELO  
NCS S 2020 - R90B  
**Blue matte | Celeste mate**  
Bleu mat | *Blau matt*  
Celeste opaco

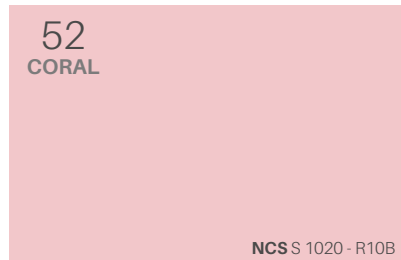

**52**  
CORAL  
NCS S 1020 - R10B  
**Pink matte | Rosa mate**  
Rose mat | *Rosa matt*  
Rosa opaco



**53**  
ARENA  
NCS S 3005 - Y50R  
**Beige matte | Beige mate**  
Beige mat | *Beige matt*  
Beige opaco

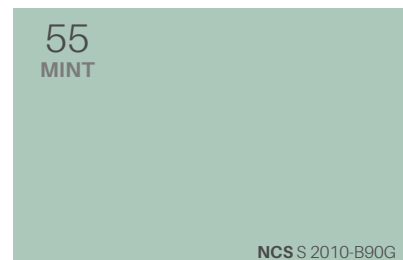

**55**  
MINT  
NCS S 2010 - B90G  
**Mint green matte | Verde menta mate**  
Vert menthe mat | *Minzgrün matt*  
Verde menta opaco

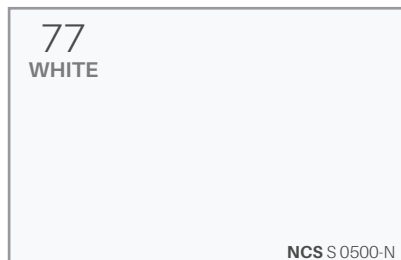

**77**  
WHITE  
NCS S 0500 - N  
**White matte | Blanco mate**  
Blanc mat | *Weiss matt*  
Bianco opaco

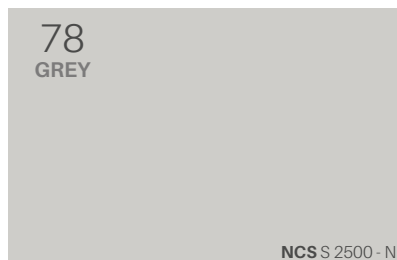

**78**  
GREY  
NCS S 2500 - N  
**Grey matte | Gris mate**  
Grise mat | *Grau matt*  
Grigio opaco

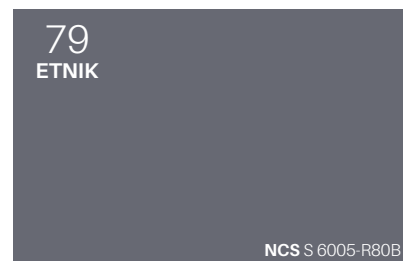

**79**  
ETNIK  
NCS S 6005 - R80B  
**Anthracite matte | Antracita mate**  
Anthracite mat | *Anthrazit matt*  
Grigio antracite opaco

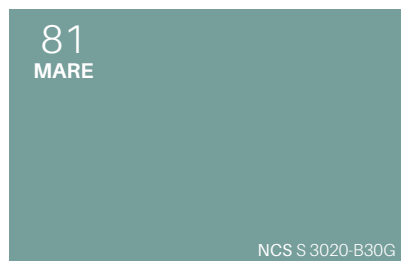

**81**  
MARE  
NCS S 3020 - B30G  
**Aquamarine matte | Verde-agua mate**  
Bleu vert mat | *Aquamarinblau matt*  
Verde acqua opaco

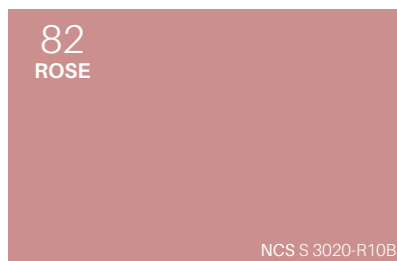

**82**  
ROSE  
NCS S 3020 - R10B  
**Old rose matte | Rosado mate**  
Vieux rose mat | *Altrosa matt*  
Rosa antico opaco

Gloss | Brillo | Brillante | Glanz | Lucido

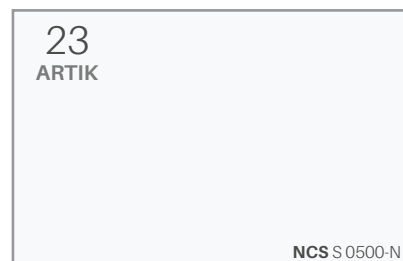

**23**  
ARTIK  
NCS S 0500 - N  
**White gloss | Blanco brillo**  
Blanc brillante | *Weiss glanz*  
Bianco lucido

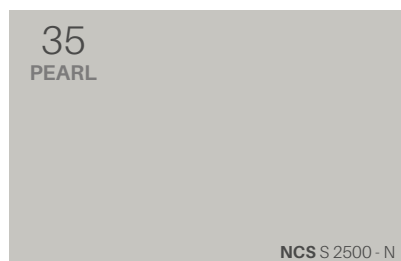

**35**  
PEARL  
NCS S 2500 - N  
**Grey gloss | Gris brillo**  
Grise brillante | *Grau glanz*  
Grigio lucido

Wood | Madera | Bois | Holz | Legno



**91**  
NATURE  
**Natural oak | Roble natural**  
Chêne naturel | *Eiche natur* | Rovere naturale



**92**  
COCO  
**White oak | Roble blanco**  
Chêne clair | *Eiche weiss* | Rovere sbiancato

## NURSING CHAIRS | SILLONES DE LACTANCIA

FAUTEUILS D'ALLAITEMENT | *STILLSSEL*

POLTRONE ALLATTAMENTO



Leatherette | Polipiel | Similicuir | *Kunstleder* | Ecopelle



A901



P153



P178



P915



P977



P979

Fabric | Tela | Tissu | *Stoff* | Tessile



T923

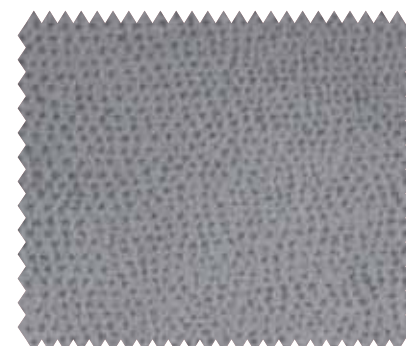

T939





**ALONDRA**

**ALONDRA INFANTIL S.L.**

Pol. Ind. Les Hortes  
C/ Riu Vinalopó, 3  
03778 BENIARBEIG (Alicante)  
Spain

Tel. +34 966 457 290

[www.alondrababy.com](http://www.alondrababy.com)



[alondrababyrooms](#)



[alondrababy](#)



[alondra](#)



[alondrababyfurniture](#)



[alondrababyrooms](#)



[alondrababyroom](#)